

Whirlpool



Health & Safety, Use & Care, Installation Guide and Online Warranty Registration Information

產品安全指引、使用說明、安裝指南及
網上登記保養資料

Model 產品型號：CS1252A / CS1252B



www.whirlpool.com.hk
www.whirlpool.com.sg

目錄

■ 使用前的準備與須知

頁

重要安全資訊	3
首次使用前須知	3
使用注意及建議事項	3-4
產品放置事項	4
接地說明	4
產品及配件結構圖	5-6
控制面板	7
控制面板 – 基本功能說明	8
控制面板 – 主要功能介紹	9
控制面板 – 主要功能詳細說明	10-11
使用及烹調小貼士	12

■ 操作方法說明

頁

設置時鐘	13
蒸氣模式	14
熱風加蒸氣模式	15
頂部 / 底部 / 上下燒烤模式	16
熱風模式	17
熱風對流模式	18
氣炸模式	19
全功能蒸焗模式	20
發酵模式	21
翻熱中式包點模式	22
翻熱西式麵包模式	23
慢煮模式	24
乾果模式	25
解凍模式	26
預熱 – 蒸氣模式	27
預熱 – 烤焗模式	28
保溫模式	29
烘乾爐腔模式	30
消毒模式	31
除垢模式	32-33
預約功能	34-35
烹調過程中調校 / 結束後追加時間功能	36-37
餘溫高溫提示	38
童鎖功能	38

■ 清潔及保養

頁

清潔及保養	39
如何拆下上發熱管	40

■ 其他須知

頁

故障排解	·
41-42 產品規格	43

■ 重要安全資訊

本說明包含有關產品安全、使用、維護及保養的重要資訊，請仔細閱讀本說明書，並將本說明書存放於容易提取的地方，以備將來查閱。

■ 首次使用前須知

1. 此產品很重，需要兩個人或以上安裝或移動此產品，必須將產品放置在堅固及平穩的表面，否則會造成身體傷害或產品損壞。
2. 此產品只設計作室內和家庭用途。請依照說明書內列明的煮食方法使用。切勿使用此產品作戶外、商業或其它用途。
3. 請確保家中使用的電壓與產品標籤上的電壓一致。
4. 產品送抵後請確保產品沒有損壞。如產品出現下列情況，請勿操作本產品：例如電源線或插頭受損、產品無法正常操作、產品受損或曾墜落。如果出現任何損壞，請聯絡惠而浦客戶服務部。
5. 切勿把電源線或插頭浸入水中，並避免電源線接觸高溫的表面，以免發生觸電，火災或其他意外。
6. 此座檯式蒸焗爐只設計作座檯式使用，不可以作嵌入式安裝。
7. 產品的四周必須保留足夠的通風空間，切勿在爐頂放置任何物件，產品上方需預留至少30厘米；左右兩旁需預留至少5厘米。
8. 請勿阻擋或堵塞蒸焗爐的散熱通風口，以免對蒸焗爐造成損壞。
9. 在使用蒸焗爐前，以「消毒模式」進行30分鐘的消毒清潔。
10. 生產商不承擔一切由於客戶不正確使用本產品而產生的問題。
11. 機身頂部排氣出風口會有蒸氣排出，切勿遮蓋排氣出風口，以免損壞蒸焗爐。
12. 應使用耐高溫容器進行烹調，如耐熱性玻璃、耐熱性塑料容器等。所有非耐熱性容器都不應放進蒸焗爐使用。蒸焗容器耐熱溫度應高於120°C，而烤焗容器耐熱溫度應高於250°C。
13. 第一次使用各種燒烤或烤焗的功能時，可能會產生氣味，這是正常現象。

■ 使用注意及建議事項

1. 如發現爐門或爐門密封邊損壞時，請停止使用產品並儘快聯絡惠而浦客戶服務部。
2. 如電源線損壞，必須由供應商/製造商或合格技術人員更換，以免造成危險。
3. 請勿於此爐附近加熱或使用易燃物品，以免產生火警或爆炸。
4. 切勿使用本產品烘乾布料、紙張、香料、藥材、木材、花朵或其他易燃的物件，否則可能會造成火災。
5. 切勿過度烹調食物，否則可能引致火災。
6. 使用蒸焗爐時切勿離開，尤其正當在使用紙、塑膠或其他易燃材料的物件進行烹調。當用作為食物加熱時，紙張可能會著火或燒焦，某些塑料則可能溶化。如發現有物件在蒸焗爐內或外被點燃或冒煙，請將爐門關上並關掉蒸焗爐。同時拔掉電源線並將裝設有漏電斷路器的插座電源切斷。
7. 切勿在爐內使用腐蝕性化學品或氣體。此蒸焗爐專為加熱食物或烹煮食物而設計，並不適合工業或實驗用途。
8. 此產品並非設計給身體、感官或精神上能力不足，或經驗及知識不足的人士使用(包括兒童)，除非監護其安全的負責人監督或指引其使用。
9. 每次完成烹調並待蒸焗爐冷卻後，請抹走可能凝固於爐腔內的殘留物。爐腔頂部最容易出現燒焦情況，應將爐腔頂部擦洗乾淨。為確保食物得到最佳烹調效果，於每次使用後，請保持爐腔完全乾透。
10. 從蒸焗爐內提取食物及器皿時，應使用隔熱手套，以免燙傷。
11. 當蒸焗爐運作時，請避免接觸爐腔內的發熱管，以免造成危險。
12. 切勿將爐腔作存放物件之用。
13. 奶樽或嬰兒食物器皿中的食物或飲料加熱後，請務必在餵食前將食物或飲料加以攪拌，並檢查食物的溫度，確保熱力分佈均勻，以避免燙傷或灼傷嬰兒。
14. 當完成蒸或烤焗煮食模式後，應等待10-15分鐘才進行其他烹調模式。
15. 剛完成烤焗煮食後或爐腔處於高溫狀態下，使用蒸氣相關模式，爐腔內的蒸氣可能會迅速蒸發，蒸氣不易被看到。這是正常現象。
16. 當使用蒸焗爐時，切勿用手觸摸爐門、爐窗及外框。

使用前的準備與須知

- 請使用直接從水喉取的自來水、食用水或蒸餾水注入儲水箱，直至水位達到標註“MAX”（最高水位）的位置。把儲水箱完整推進於凹位內，直至聽到「卡」一聲，確保固定到位。
- 水箱出現裂紋或缺口時，請勿繼續使用，以免引起因漏水而導致的漏電或觸電。
- 為確保衛生，並防止冷凝水在蒸爐內積聚，請於每次使用後清空水箱及確保爐腔完全乾透。
- 除清水外，切勿使用儲水箱盛載其他液體（除垢劑除外）。
- 以蒸氣模式烹調過程中儘量不要打開爐門，以免蒸氣流失和爐腔溫度下降，影響烹調效果。如有需要打開爐門，請酌量增加蒸煮時間。
- 烹調過程中如需翻轉食物或因其他需要必須打開爐門時，請盡量不要靠近爐門（特別是臉部），以免燙傷。
- 維修必須由專業人員進行。除專業人員外，任何維修均可能帶來危險。請勿擅自對產品進行拆卸、修理或改造。
- 產品操作時，可接觸部份的溫度可能較高，切勿讓兒童靠近。
- 通電後，切勿以濕手或其他身體部份接觸本產品、產品之電源線或插頭，以免發生危險。
- 切勿放置或懸掛任何物件於爐門或門上的把手，以免影響門的開關及損壞門鉸。
- 某些烹調程式結束後，電動風扇會繼續工作一段時間，以冷卻爐腔和電子零件，屬於正常現象。
- 如未能妥善清潔產品及其配件，會導致器具表面劣化，這會影響器具的壽命，可能會導致危險的情況。
- 清潔前請切斷電源，不可使用具有腐蝕性的清潔劑，以免損壞或腐蝕本產品。
- 在除垢模式時，水箱的水會被加熱，並流到接水盤內，請勿讓兒童接觸或走近。
- 在清潔爐腔時，請切斷電源。
- 請定期清除電源插頭上的灰塵。長期不使用時，請拔出電源插頭。拔除電源插頭時不要拉扯電線，應手握插頭拔除。
- 請不要讓蒸焗爐處於無人監看的狀態下工作。
- 過熱的脂肪和油很容易著火。除了烤肉，在烹調過程中對油進行加熱也是很危險的，應禁止這樣操作。
- 爐門負重不可超過4.5公斤，為避免損害蒸焗爐，請勿把食物或任何重物放在爐門上。

- 請勿堵塞爐門感應器，否則會造成意外及造成火災。
- 此蒸焗爐不可以接駁及透過外置計時裝置或遙遠控制系統使用。
- 烹調過程中或完結後水箱溫度可能偏高。



- 需要監管兒童，不要讓兒童玩此產品。

■ 產品放置事項

- 產品的四周必須有足夠的通風空間，切勿在爐頂放置任何物件，產品上方需預留至少30厘米；左右兩旁需預留至少5厘米；機背可貼近牆壁。

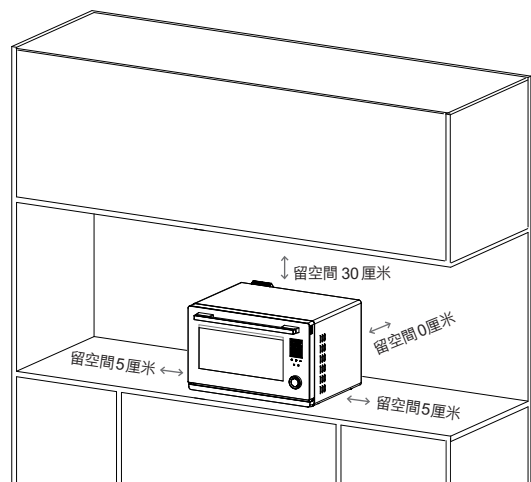

- 請勿堵塞出風口，入氣口，否則可能造成火災。請經常保養，避免垃圾、灰塵等堵塞出風口，入氣口。
- 不可將產品放置於高溫潮濕地方。例如煤氣爐，帶電區或水槽旁邊等。
- 產品必須平放在堅固及平穩的表面。

■ 接地說明

本產品必須接地使用。萬一漏電，接地可以提供電流回路以避免觸電。本產品提供的接地插頭必須插在單相兩極帶接地的插座上。

使用前的準備與須知

■ 產品及配件結構圖

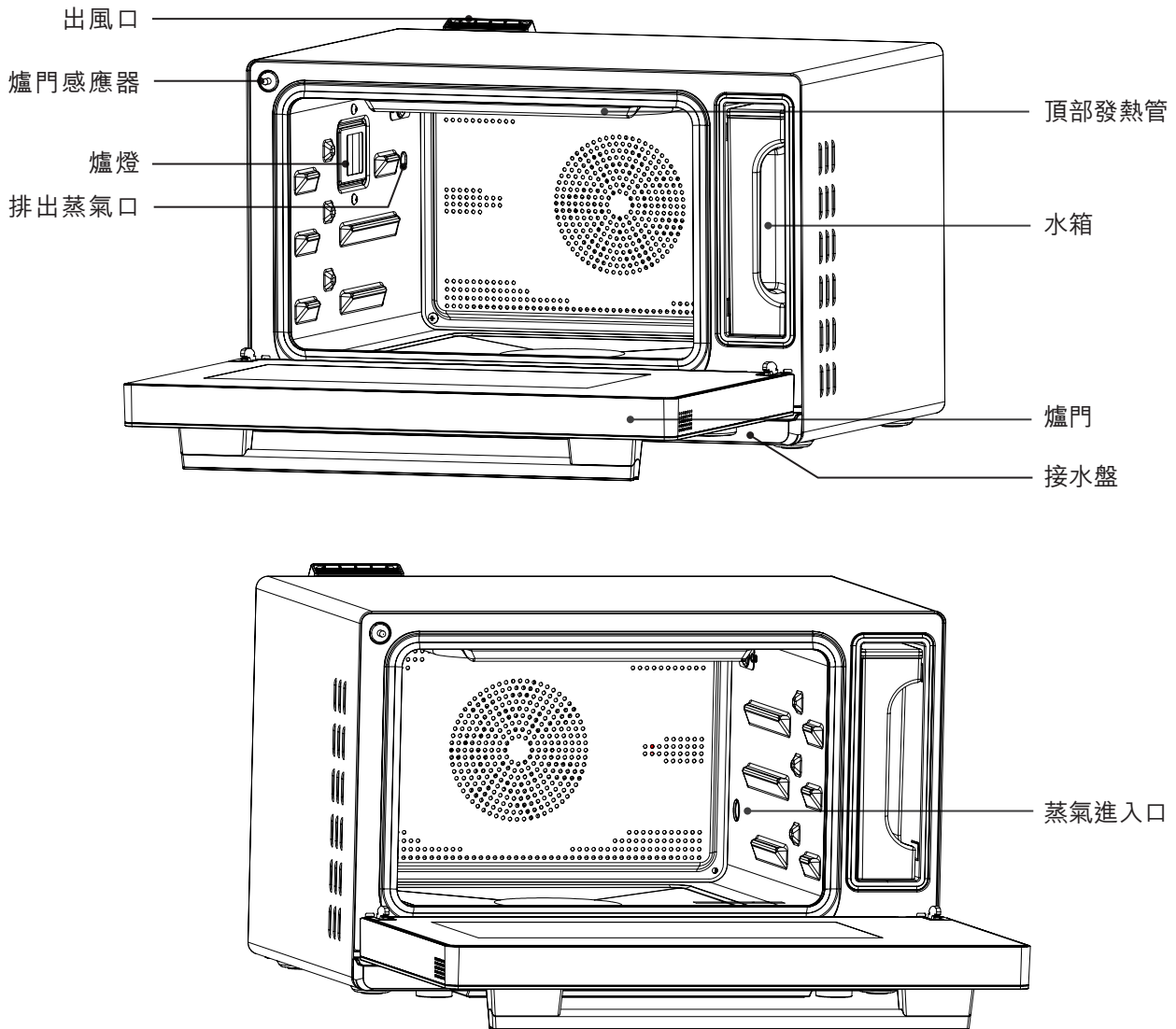

1. **控制面板**：用於操作蒸焗爐(詳細請參考控制面板說明 P.7-11)
2. **出風口**：排出爐內多餘的熱氣及水蒸氣。
3. **爐燈**：爐腔照明，以便觀察烹調的食物。
4. **排出蒸氣口**：爐腔內多餘的蒸氣由此孔排出。
5. **頂部發熱管**：產生熱能烹調食物。
6. **水箱**：盛載清水以產生蒸氣。
7. **蒸氣進入口**：讓蒸氣進入爐腔內。
8. **爐門**：1. 確保爐門關上後，才開啟烹調程式。
2. 在烹調過程中，將爐門打開，烹調會暫停；把爐門關上後，會自動繼續原先的烹調設定。
9. **接水盤**：盛載開門後流出的倒汗水及除垢功能中的污水。
10. **爐門感應器**：感應爐門是否關上。

使用前的準備與須知

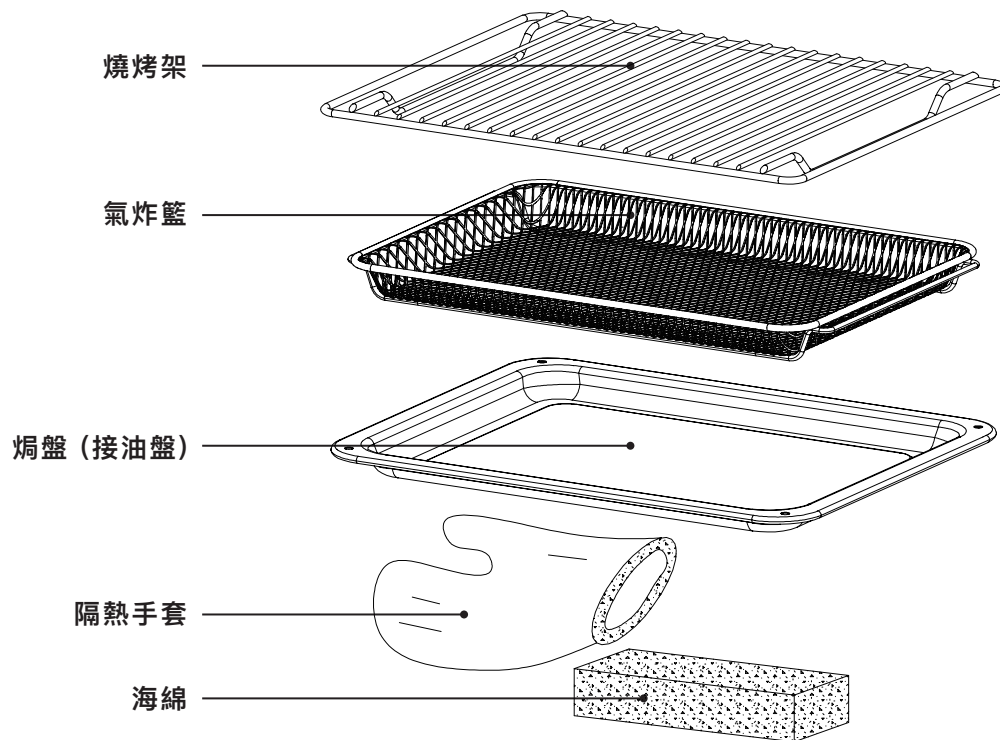

1. 燒烤架

- (A) 如需進行多層煮食，建議將此燒烤架放於較底層的位置，如進行二層煮食，請放於下層位置。可使爐腔內空氣更流通、讓爐腔溫度更平均。
- (B) 食物無容器盛放時，請用牛油紙或錫紙，平鋪在燒烤架上使用。
- (C) 燒烤架上可承受的最大重量為4公斤。

2. 氣炸籃

主要於「氣炸」模式時使用。

3. 焗盤

- (A) 食物無容器盛放時，請用牛油紙或錫紙，平鋪在金屬盤上使用。
- (B) 焗盤上可承受的最大重量為5公斤。

4. 隔熱手套

由蒸焗爐拿出食物或托盤時使用。

5. 海綿

用於吸取爐腔內的倒汗水。

使用前的準備與須知

■ 控制面板

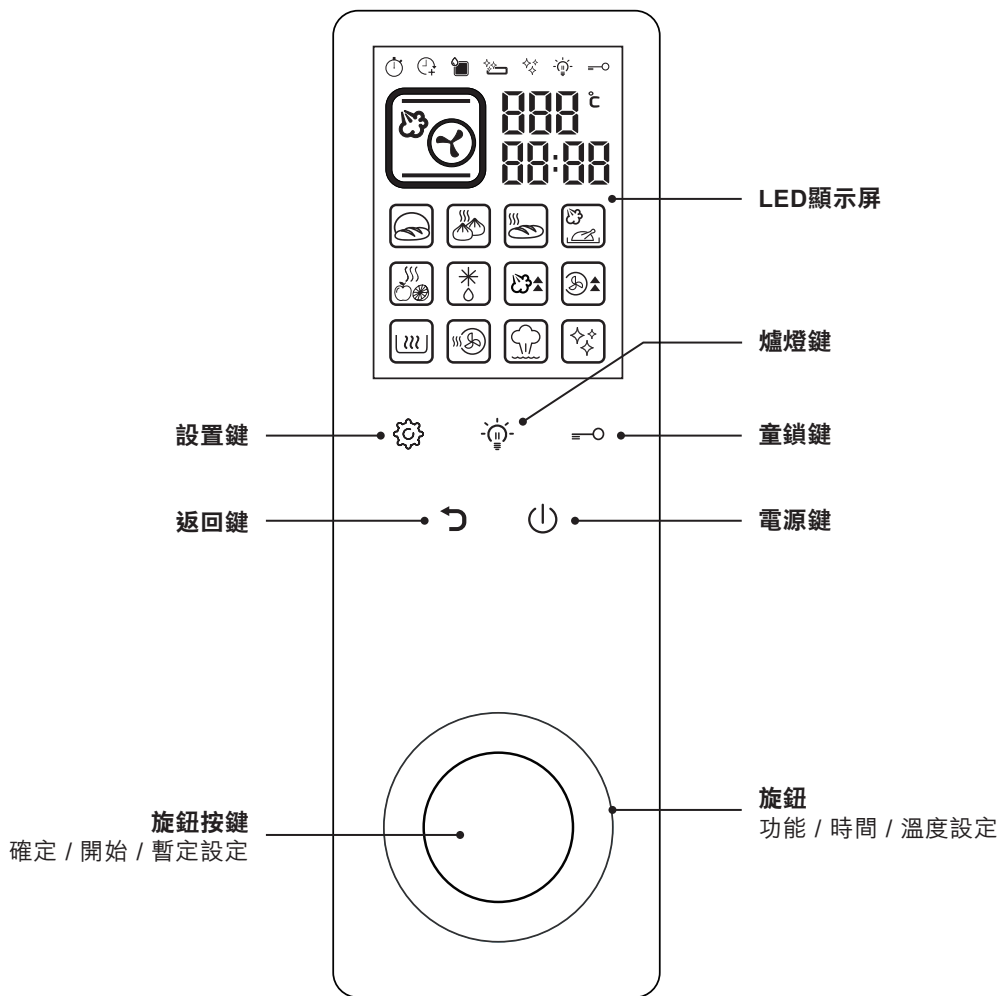
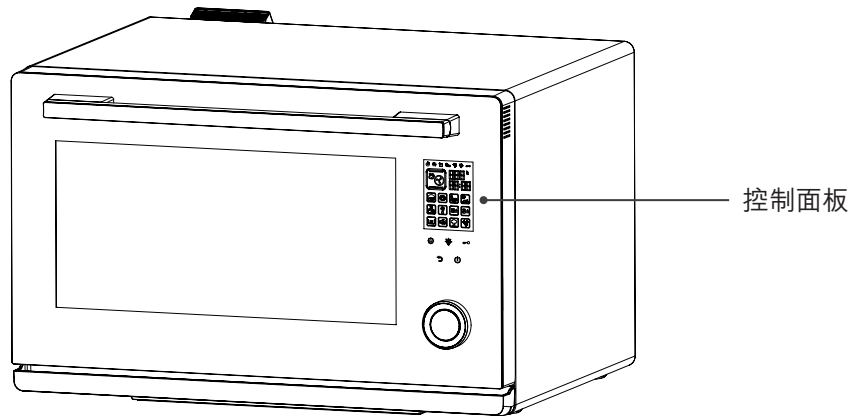

使用前的準備與須知

■ 控制面板 – 基本功能說明





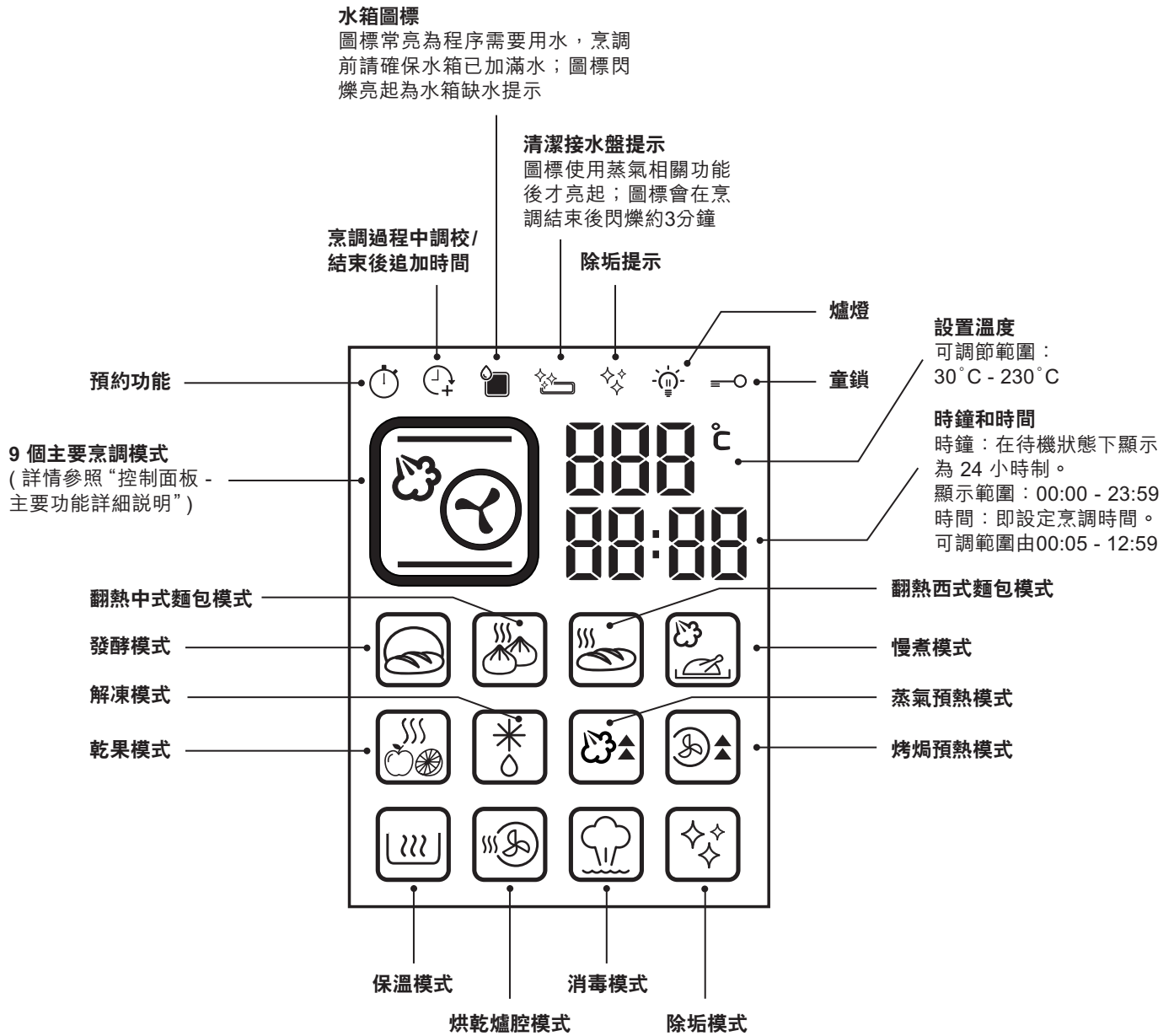





圖示	功能說明
	旋鈕 功能 / 時間 / 溫度設定 旋鈕按鍵 確定 / 開始 / 暫停設定
	設置鍵 1. 時鐘設定：在待機狀態下長按設置鍵 3 秒鐘，即可進入設置時鐘畫面，進行時鐘設定。（詳細請參閱第 13 頁“設置時鐘”）； 2. 預約功能設定：烹調模式、烹調時間和烹調溫度設定後，按設置鍵，即可進入預約功能畫面，進行預約設定。（詳細請參閱第 34-35 頁“預約功能”）； 3. 在暫停狀態下，按設置鍵可重新調整烹調時間和溫度。（詳細請參閱第 36 頁“烹調過程中調校功能”）
	返回鍵 1. 返回 / 取消； 2. 在設置過程中，按返回鍵可回到上一個畫面，即可重新調整烹調模式或烹調時間。
	爐燈鍵 1. 輕按一次，爐燈亮 3 分鐘，顯示屏上不會顯示爐燈圖標； 2. 長按 3 秒，爐燈長亮，顯示屏上會顯示爐燈圖標，再長按 3 秒取消長亮； 3. 打開爐門，爐燈亮 3 分鐘。
	童鎖鍵 長按 3 秒可啟動 / 解除童鎖。 啟動童鎖：長按童鎖鍵 3 秒啟動，控制面板會被鎖定並不能控作。 解除童鎖：長按童鎖鍵 3 秒即可解除童鎖功能。
	電源鍵 如果開啟蒸焗爐後，沒有進行任何操作，包括打開或關閉爐門，5 分鐘後，蒸焗爐將自動進入省電模式，顯示屏會熄滅。省電模式下只有電源鍵能操作。

■ 控制面板 - 主要功能介紹



使用前的準備與須知

■ 控制面板 – 主要功能詳細說明

圖示	模式	功能介紹	默認時間 / 溫度	時間 / 溫度選擇範圍
	蒸氣	此模式以蒸氣烹調食物，可保留食物原有的味道，營養及顏色。適合蒸煮蔬菜，肉類，海鮮或燉湯等。	30分鐘 / 100°C	時間 5 – 419 分鐘 (最長 6 小時 59 分鐘) 溫度 50 – 110°C
	熱風加蒸氣	以熱風煮食並加入蒸氣，讓烹調的食物不會因烤焗的高溫而流失水份。背部風扇使熱風均勻循環流動，可確保多層烤焗的食物受熱更平均。適用於煮各種食物。	30分鐘 / 180°C	時間 5 – 90 分鐘 (最長 1 小時 30 分鐘) 溫度 100 – 230°C
	頂部燒烤	適合燒烤食材，或用於烤焗的最後階段，作加強食物金黃度及烤色的作用。	30分鐘 / 180°C	時間 5 – 90 分鐘 (最長 1 小時 30 分鐘) 溫度 100 – 230°C
	底部燒烤	適合烘焙的最後階段或局部時段只需底部加熱的食物，如薄餅或馬卡龍等菜式。熱力會從底部散發出來。	30分鐘 / 180°C	時間 5 – 90 分鐘 (最長 1 小時 30 分鐘) 溫度 100 – 230°C
	上下燒烤	傳統的一層烘焙與烤焗。熱力會從上面及底部散發出來，使食物達到均勻的烤焗效果。適用於烹調肉類、魚類、麵包以及各式曲奇、糕點及甜品等。尤其適合頂部有濕潤配料的蛋糕。	30分鐘 / 180°C	時間 5 – 90 分鐘 (最長 1 小時 30 分鐘) 溫度 100 – 230°C
	熱風	設有風扇在背部，風扇會將背部發熱線產生的熱氣，均勻的送到爐中每一個角落。使多層烤焗的食物受熱更平均。可使用於一層或以上的烤焗。	30分鐘 / 180°C	時間 5 – 90 分鐘 (最長 1 小時 30 分鐘) 溫度 100 – 230°C
	熱風對流	上下發熱線及背部風扇同時運作，用於各種烤焗菜式，如肉類、海鮮類、薄餅、麵包以及各式曲奇、糕點及甜品等。	30分鐘 / 180°C	時間 5 – 90 分鐘 (最長 1 小時 30 分鐘) 溫度 100 – 230°C
	氣炸	以風扇將熱力在爐腔內運行產生對流以較短時間烤焗食物造出香脆效果。適用於需要氣炸的食物或烤焗體積較大的肉類。	30分鐘 / 180°C	時間 5 – 90 分鐘 (最長 1 小時 30 分鐘) 溫度 100 – 230°C
	全功能蒸焗	此模式集合上下火、熱風、蒸氣功能於一身，全功能的完美結合。煮食過程中加入蒸氣，讓烹調的食物不會因烤焗而流失水份。適用於煮各種食物。例如較大的肉類或烤焗濕潤的蛋糕。	30分鐘 / 180°C	時間 5 – 90 分鐘 (最長 1 小時 30 分鐘) 溫度 100 – 230°C
	發酵	此模式以蒸氣運作，使爐腔達至調校的穩定而潮濕的環境。用於麵團發酵，例如薄餅的餅底或製作麵包時的麵團。麵團發酵的速度會比在室溫下快，麵團表面也不會過乾。	30分鐘 / 35°C	時間 5 – 419 分鐘 (最長 6 小時 59 分鐘) 溫度 30 – 40°C

■ 控制面板 - 主要功能詳細說明

圖示	模式	功能介紹	默認時間 / 溫度設置	時間 / 溫度選擇範圍
	翻熱中式包點	此程式會以已調節的最佳溫度去翻熱麵包，過程中加入蒸氣，使效果像剛出爐的新鮮包點。	10 分鐘 / 100°C	時間 5 - 59 分鐘 溫度不可調校
	翻熱西式麵包	此程式會以已調節的最佳溫度去翻熱麵包，過程中透過上下發熱管加熱，以烘烤麵包，使效果像剛出爐的新鮮麵包。	10 分鐘 / 160°C	時間 5 - 59 分鐘 溫度不可調校
	慢煮	以蒸氣維持爐腔的溫度。以低溫慢煮，沒有經過高溫加熱，可使各種肉類和海鮮保存原有的鮮味。需配合真空袋使用。	30 分鐘 / 60°C	時間 5 - 419 分鐘 (最長6小時59分鐘) 溫度50-90°C
	乾果	以低溫熱風去風乾食物，適合製作各種生果片，蔬菜片或肉乾。	60 分鐘 / 80°C	時間 5 - 779 分鐘 (最長12小時59分鐘) 溫度40-90°C
	解凍	用於解凍冷藏或冷凍食物。	30 分鐘 / 55°C	時間 5 - 419 分鐘 (最長6小時59分鐘) 溫度 50 - 60°C
	預熱 - 蒸氣	以蒸氣進行預熱。使爐腔達到預設溫度。	當前時間 / 100°C	溫度 50 - 110°C
	預熱 - 烤焗	以烤焗進行預熱。使爐腔達到預設溫度。	當前時間 / 180°C	溫度 100 - 230°C
	保溫	以熱風保溫食物。適合把剛煮的食物保溫。	30 分鐘 / 55°C	時間 5 - 239 分鐘 (最長3小時59分鐘) 溫度 50 - 60°C
	烘乾爐腔	此模式會以高溫加熱爐腔，蒸發爐腔中多餘的水份和蒸氣。此功能適用於任何蒸氣烹調的模式後使用。	25 分鐘 / 230°C	時間不可調校 溫度不可調校
	消毒	以高溫蒸氣消毒，可消毒餐具或嬰兒奶瓶等。	30 分鐘 / 110°C	時間 5 - 419 分鐘 (最長6小時59分鐘) 溫度不可調校
	除垢	當蒸氣模式或其他帶有蒸氣功能模式使用的累計時間達到100個小時，“除垢提示”圖示會亮起，提醒用戶進行除垢模式。需配合除垢劑使用。	50 分鐘 / 85°C	時間不可調校 溫度不可調校

■ 使用及烹調小貼士

1. 所有烹調模式的最短設定的時間為 5 分鐘。
(除‘追加烹調時間’功能外)
2. 完成某些烹調程式後，風扇會延時工作 3 分鐘，將爐腔內的熱量排出，這是正常現象。
3. 烹調過程中，如果將爐門打開，蒸焗爐會自動暫停；將爐門關上，則自動啟動並按餘下設定時間及溫度繼續烹調。
4. 加熱湯類、汁類或飲品等液體食物時，取出時必須小心。在烹調時，請留意以下各點：
 - (a) 不要過度加熱。否則在取出食物時，會由於突然沸騰導致液體飛濺而燙傷。
 - (b) 液體食物加熱時，液體不要多於容器的八成滿。因為加熱少量液體食物會由於沸騰而導致液體突然飛濺。
 - (c) 加熱前或加熱途中請攪拌。
 - (d) 加熱後，先讓食物在爐內放置片刻，略加攪拌後取出。
 - (e) 使用奶瓶或加熱嬰兒食物後，即攪拌或搖動，餵食前應檢查溫度，避免燙傷。
5. 如要在烹調過程中，檢查食物溫度，必須使用焗爐專用的溫度計檢查。如果食物烹調時間不足則再放入爐內繼續烹調。
6. 烤焗完成後，建議立刻取出，以免殘留熱量使食物過熱或使烤色變深。
7. 烤焗過程中為維持爐內溫度，請儘量避免開關爐門檢查食物，以免影響爐內溫度。如於煮食過程中曾打開爐門，請相應地增加烹調時間。
8. 如果擔心烤色不均勻，請在加熱途中調整或翻轉食物、蒸焗盤的位置或方向。

■ 設置時鐘

首次開機後，蒸焗爐發出「必」一聲後即進入待機畫面，時鐘默認顯示 12:00 (如下圖)，顯示屏全亮。



在開機後畫面後，若在 5 分鐘內沒有進行任何操作，會自動進入省電模式，此時顯示屏熄滅，省電模式下只有電源鍵能操作。省電模式下按“電源鍵”退出省電模式，機器進入開機後畫面。

例如：設置現前時間為 13 時 20 分。

操作步驟：

1. 在待機畫面下，長按設置鍵  3 秒，小時位閃爍 (如下圖)；



2. 轉動旋鈕直到顯示小時位轉至 13，按旋鈕確認。(如下圖) 然後畫面會自動跳至分鐘選項。



3. 轉動旋鈕直到顯示分鐘轉至 20，按旋鈕確認。(如下圖)



4. 完成時間設置。(如下圖)



注意：在設置過程中，若連續 5 分鐘內用戶沒有任何操作，當前所有設置將會被取消並返回到待機畫面，進入待機狀態。

操作方法說明

■ 蒸氣模式

此模式以蒸氣烹調食物，可保留食物原有的味道，營養及顏色。適合蒸煮蔬菜，肉類，海鮮或燉湯等。每次使用前，請確保水箱已加滿水。

	溫度	時間
開機預設	100 °C	30 分鐘
設定範圍	50 °C - 110 °C	5 分鐘 - 6 小時 59 分鐘

例如：設置烹調時間為 1 小時 40 分鐘，溫度為 90 °C。

操作步驟：

1. 在待機狀態下，順時針旋轉旋鈕至  蒸氣模式圖示閃爍，按旋鈕確認功能。(如下圖) 然後畫面會自動跳至溫度選項。

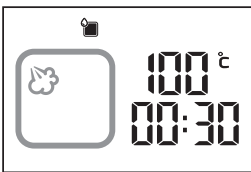

2. 轉動旋鈕直到顯示溫度轉至 90 °C，按旋鈕確認。(如下圖) 然後畫面會自動跳至小時選項。

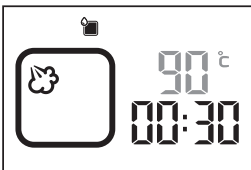

3. 轉動旋鈕直到顯示小時位轉至 01，按旋鈕確認。(如下圖) 然後畫面會自動跳至分鐘選項。

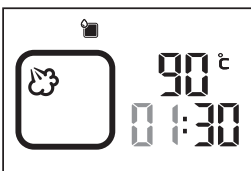

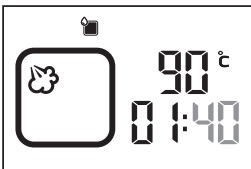

4. 轉動旋鈕直到顯示分鐘轉至 40，按旋鈕確認。(如下圖)

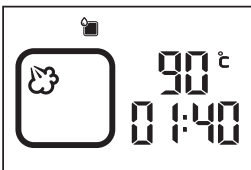

5. 設置完成，開始烹調。(如下圖)



烹調結束時，顯示屏會顯示“END”並發出聲效，提示操作已完成。同時顯示屏上  增加烹調時間圖示(在烹調結束後，客人可按需要追加烹調時間)和  清除接水盤提示圖示(提示客人有可能需要清除接水盤的水)會閃爍。

操作方法說明

■ 熱風加蒸氣模式

以熱風煮食並加入蒸氣，讓烹調的食物不會因烤焗的高溫而流失水份。背部風扇使熱風均勻循環流動，可確保多層烤焗的食物受熱更平均。適用於煮各種食物。可把食物放在鋪有錫紙或牛油紙的焗盤上直接烤焗。每次使用前，請確保水箱已加滿水。

	溫度	時間
開機預設	180°C	30 分鐘
設定範圍	100°C - 230°C	5 分鐘 - 1 小時 30 分鐘

例如：設置烹調時間為40分鐘，溫度為210°C。

操作步驟：

1. 在待機狀態下，順時針旋轉旋鈕至  熱風加蒸氣模式圖示閃爍，按旋鈕確認功能。(如下圖)然後畫面會自動跳至溫度選項。

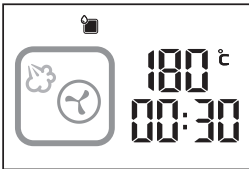

2. 轉動旋鈕直到顯示溫度轉至210°C，按旋鈕確認。(如下圖)然後畫面會自動跳至小時選項。

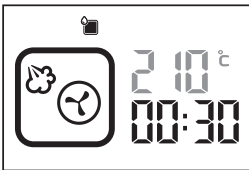

3. 按旋鈕確認小時位00設定。(如下圖)然後畫面會自動跳至分鐘選項。

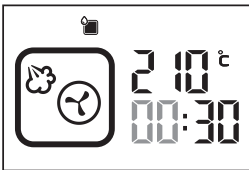

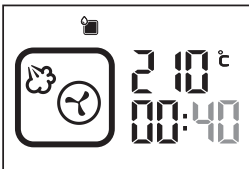

4. 轉動旋鈕直到顯示分鐘轉至40，按旋鈕確認。(如下圖)

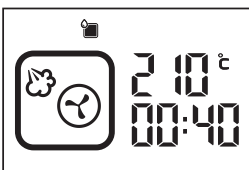

5. 設置完成，開始烹調。(如下圖)



烹調結束時，顯示屏會顯示“END”並發出聲效，提示操作已完成。同時顯示屏上  增加烹調時間圖示(在烹調結束後，客人可按需要追加烹調時間)和  清除接水盤提示圖示(提示客人有可能需要清除接水盤的水)會閃爍。

操作方法說明

■ 頂部 / 底部 / 上下燒烤模式

設有三種不同的燒烤模式，分別為頂部燒烤模式，底部燒烤模式和上下燒烤模式（頂部及底部燒烤）。可因應食材種類和所需的烹調效果去選擇合適的燒烤模式。可把食物放在鋪有錫紙或牛油紙的燒烤架或焗盤上直接烤焗。

頂部燒烤模式：適合燒烤食材或用於烤焗的最後階段，作加強食物金黃度及烤色的作用。

底部燒烤模式：適合烘焙的最後階段或局部時段只需底部加熱的食物，如薄餅或馬卡龍等菜式。熱力會從底部散發出來。

上下燒烤模式：傳統的一層烘焙與烤焗。熱力會從上面及底部散發出來，使食物達到均勻的烤焗效果。適用於烹調肉類、魚類、麵包以及各式曲奇、糕點及甜品等。尤其適合頂部有濕潤配料的蛋糕。

	溫度	時間
開機預設	180°C	30 分鐘
設定範圍	100°C - 230°C	5 分鐘 - 1 小時 30 分鐘

例如：設置烹調時間為 40 分鐘，溫度為 210°C。

操作步驟：

1. 在待機狀態下，順時針旋轉旋鈕至  或  或  所需燒烤模式圖示閃爍，按旋鈕確認功能。（如下圖）然後畫面會自動跳至溫度選項。



2. 轉動旋鈕直到顯示溫度轉至 210°C，按旋鈕確認。（如下圖）然後畫面會自動跳至小時選項。



3. 按旋鈕確認小時位 00 設定。（如下圖）然後畫面會自動跳至分鐘選項。



4. 轉動旋鈕直到顯示分鐘轉至 40，按旋鈕確認。（如下圖）



5. 設置完成，開始烹調。（如下圖）



烹調結束時，顯示屏會顯示“END”並發出聲效，提示操作已完成。同時顯示屏上  增加烹調時間圖示（在烹調結束後，客人可按需要追加烹調時間）會閃爍。

操作方法說明

■ 熱風模式

設有風扇在背部，風扇會將背部發熱線產生的熱氣，均勻地送到爐中每一個角落。使多層烤焗的食物受熱更平均。可使用於一層或以上的烤焗。可把食物放在鋪有錫紙或牛油紙的焗盤上直接烤焗。

	溫度	時間
開機預設	180°C	30 分鐘
設定範圍	100°C - 230°C	5 分鐘 - 1 小時 30 分鐘

例如：設置烹調時間為 40 分鐘，溫度為 210°C。

操作步驟：

1. 在待機狀態下，順時針旋轉旋鈕至  熱風模式圖示閃爍，按旋鈕確認功能。(如下圖)然後畫面會自動跳至溫度選項。

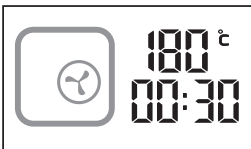

2. 轉動旋鈕直到顯示溫度轉至 210°C，按旋鈕確認。(如下圖)然後畫面會自動跳至小時選項。



3. 按旋鈕確認小時位00設定。(如下圖)然後畫面會自動跳至分鐘選項。



4. 轉動旋鈕直到顯示分鐘轉至 40，按旋鈕確認。(如下圖)



5. 設置完成，開始烹調。(如下圖)



烹調結束時，顯示屏會顯示“END”並發出聲效，提示操作已完成。同時顯示屏上  增加烹調時間圖示(在烹調結束後，客人可按需要追加烹調時間)會閃爍。

操作方法說明

■ 熱風對流模式

上下發熱線及背部風扇同時運作，用於各種烤焗菜式，如肉類、海鮮類、薄餅、麵包以及各式曲奇、糕點及甜品等。可把食物放在鋪有錫紙或牛油紙的燒烤架或焗盤上直接烤焗。

	溫度	時間
開機預設	180°C	30 分鐘
設定範圍	100°C - 230°C	5 分鐘 - 1 小時 30 分鐘

例如：設置烹調時間為 40 分鐘，溫度為 210°C。

操作步驟：

1. 在待機狀態下，順時針旋轉旋鈕至  熱風對流模式圖示閃爍，按旋鈕確認功能。(如下圖) 然後畫面會自動跳至溫度選項。



2. 轉動旋鈕直到顯示溫度轉至 210°C，按旋鈕確認。(如下圖) 然後畫面會自動跳至小時選項。



3. 按旋鈕確認小時位 00 設定。(如下圖) 然後畫面會自動跳至分鐘選項。



4. 轉動旋鈕直到顯示分鐘轉至 40，按旋鈕確認。(如下圖)



5. 設置完成，開始烹調。(如下圖)



烹調結束時，顯示屏會顯示“END”並發出聲效，提示操作已完成。同時顯示屏上  增加烹調時間圖示(在烹調結束後，客人可按需要追加烹調時間)會閃爍。

操作方法說明

■ 氣炸模式

以風扇將熱力在爐腔內運行產生對流以較短時間烤焗食物造出香脆效果。適用於需要氣炸的食物或烤焗體積較大的肉類。

	溫度	時間
開機預設	180°C	30 分鐘
設定範圍	100°C – 230°C	5 分鐘 – 1 小時 30 分鐘

例如：設置烹調時間為 40 分鐘，溫度為 210°C。

操作步驟：

1. 在待機狀態下，順時針旋轉旋鈕至  氣炸模式圖示閃爍，按旋鈕確認功能。(如下圖) 然後畫面會自動跳至溫度選項。



2. 轉動旋鈕直到顯示溫度轉至 210°C，按旋鈕確認。(如下圖) 然後畫面會自動跳至小時選項。



3. 按旋鈕確認小時位 00 設定。(如下圖) 然後畫面會自動跳至分鐘選項。



4. 轉動旋鈕直到顯示分鐘轉至 40，按旋鈕確認。(如下圖)



5. 設置完成，開始烹調。(如下圖)



烹調結束時，顯示屏會顯示“END”並發出聲效，提示操作已完成。同時顯示屏上  增加烹調時間圖示(在烹調結束後，客人可按需要追加烹調時間)會閃爍。

操作方法說明

■ 全功能蒸焗模式

此模式集合上下火、熱風、蒸氣功能於一身，全功能的完美結合。煮食過程中加入蒸氣，讓烹調的食物不會因烤焗而流失水份。適用於煮各種食物。例如較大的肉類或烤焗濕潤的蛋糕。可把食物放在鋪有錫紙或牛油紙的焗盤上直接烤焗。每次使用前，請確保水箱已加滿水。

	溫度	時間
開機預設	180°C	30 分鐘
設定範圍	100°C - 230°C	5 分鐘 - 1 小時 30 分鐘

例如：設置烹調時間為 40 分鐘，溫度為 210°C。

操作步驟：

1. 在待機狀態下，順時針旋轉旋鈕至  全功能蒸焗模式圖示閃爍，按旋鈕確認功能。(如下圖) 然後畫面會自動跳至溫度選項。

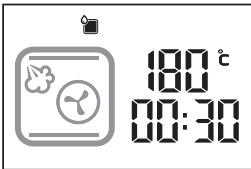

2. 轉動旋鈕直到顯示溫度轉至 210°C，按旋鈕確認。(如下圖) 然後畫面會自動跳至小時選項。

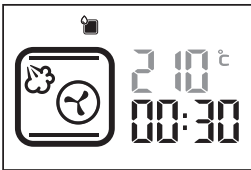

3. 按旋鈕確認小時位 00 設定。(如下圖) 然後畫面會自動跳至分鐘選項。

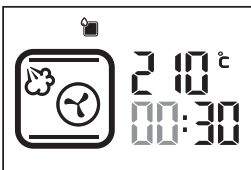

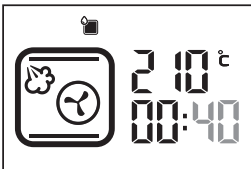

4. 轉動旋鈕直到顯示分鐘轉至 40，按旋鈕確認。(如下圖)

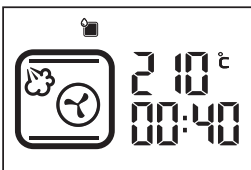

5. 設置完成，開始烹調。(如下圖)



烹調結束時，顯示屏會顯示“END”並發出聲效，提示操作已完成。同時顯示屏上  增加烹調時間圖示(在烹調結束後，客人可按需要追加烹調時間)和  清除接水盤提示圖示(提示客人有可能需要清除接水盤的水)會閃爍。

操作方法說明

■ 發酵模式

此模式以蒸氣運作，使爐腔達至已調校的穩定而潮濕的環境。用於麵糰發酵：如薄餅的餅底或製作麵包的麵糰。麵糰發酵速度會較室溫下快，麵糰表面也不會過乾。每次使用前，請確保水箱已加滿水。

	溫度	時間
開機預設	35°C	30 分鐘
設定範圍	30°C - 40°C	5 分鐘 - 6 小時 59 分鐘

例如：設置烹調時間為 40 分鐘，溫度為 35°C。

操作步驟：

1. 在待機狀態下，順時針旋轉旋鈕至  發酵模式圖示閃爍，按旋鈕確認功能。(如下圖) 然後畫面會自動跳至溫度選項。

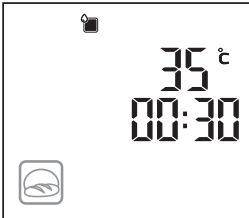

2. 按旋鈕確認溫度 35°C 的設定。(如下圖) 然後畫面會自動跳至小時選項。

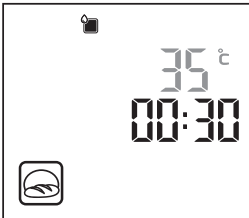

3. 按旋鈕確認小時位 00 設定。(如下圖) 然後畫面會自動跳至分鐘選項。

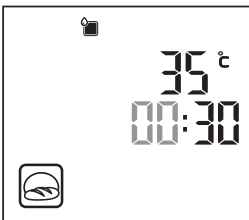

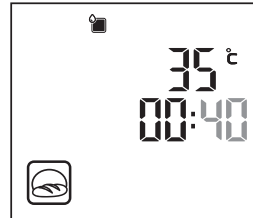

4. 轉動旋鈕直到顯示分鐘轉至 40，按旋鈕確認。(如下圖)

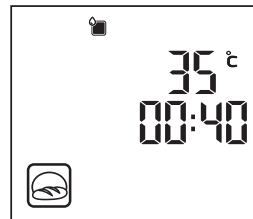

5. 設置完成，開始烹調。(如下圖)



烹調結束時，顯示屏會顯示“END”並發出聲效，提示操作已完成。

同時顯示屏上  增加烹調時間圖示(在烹調結束後，客人可按需要追加烹調時間)和  清除接水盤提示圖示(提示客人有可能需要清除接水盤的水)會閃爍。

操作方法說明

■ 翻熱中式包點模式

此程式會以已調節的最佳溫度去翻熱包點，過程中加入蒸氣，使效果像剛出爐的新鮮包點。每次使用前，請確保水箱已加滿水。

建議烹調時間：一般冷藏麵包所需翻熱時間大約是 10-15 分鐘；室溫麵包所需翻熱時間大約是 8-13 分鐘。如果有餡的麵包則視乎需要增加烹調時間。此建議烹調時間僅供參考。客人需因應麵包份量、大小、種類和個人喜好等自行調整翻熱時間。

	溫度	時間
開機預設	100 °C	10 分鐘
設定範圍	不可調較	5 分鐘 - 59 分鐘

例如：烹調從雪櫃取出的麵包，設置烹調時間為 25 分鐘。

操作步驟：

1. 在待機狀態下，順時針旋轉旋鈕至  翻熱中式包點模式圖示閃爍，按旋鈕確認功能。(如下圖) 然後畫面會自動跳至分鐘選項。

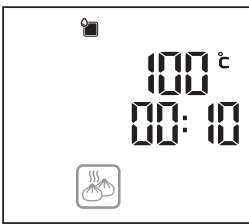

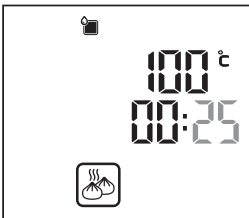

2. 轉動旋鈕直至顯示分鐘轉至 25，按旋鈕確認。(如下圖)

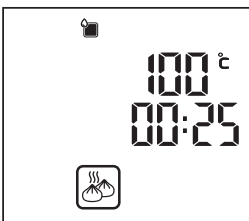

3. 設置完成，開始烹調。(如下圖)



烹調結束時，顯示屏會顯示“END”並發出聲效，提示操作已完成。同時顯示屏上  增加烹調時間圖示(在烹調結束後，客人可按需要追加烹調時間)和  清除接水盤提示圖示(提示客人有可能需要清除接水盤的水)會閃爍。

操作方法說明

■ 翻熱西式麵包模式

此程式會以已調節的最佳溫度去翻熱麵包，使效果像剛出爐的新鮮麵包。

建議烹調時間：一般冷藏麵包所需翻熱時間大約是 10-15 分鐘；室溫麵包所需翻熱時間大約是 8-13 分鐘。如果有餡的麵包則視乎需要增加烹調時間。此建議烹調時間僅供參考。客人需因應麵包份量、大小、種類和個人喜好等自行調整翻熱時間。

	溫度	時間
開機預設	160 °C	10 分鐘
設定範圍	不可調較	5 分鐘 - 59 分鐘

例如：烹調從雪櫃取出的麵包，設置烹調時間為 25 分鐘。

操作步驟：

1. 在待機狀態下，順時針旋轉旋鈕至  翻熱西式麵包模式圖示閃爍，按旋鈕確認功能。(如下圖) 然後畫面會自動跳至分鐘選項。

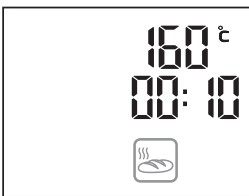

2. 轉動旋鈕直至顯示分鐘轉至 25，按旋鈕確認。(如下圖)



3. 設置完成，開始烹調。(如下圖)

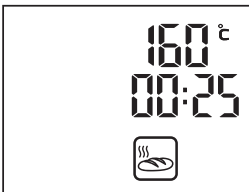

烹調結束時，顯示屏會顯示“END”並發出聲效提示，提示操作已完成。同時顯示屏上  增加烹調時間圖示(在烹調結束後，客人可按需要追加烹調時間)會閃爍。

操作方法說明

■ 慢煮模式

以蒸氣維持爐腔的溫度。以低溫慢煮，沒有經過高溫加熱，可使各種肉類和海鮮保存原有的鮮味。需配合真空袋使用。每次使用前，請確保水箱已加滿水。

	溫度	時間
開機預設	60°C	30 分鐘
設定範圍	50°C - 90°C	5 分鐘 - 6 小時 59 分鐘

例如：設置烹調時間為 40 分鐘，溫度為 60°C。

操作步驟：

1. 在待機狀態下，順時針旋轉旋鈕至  慢煮模式圖示閃爍，按旋鈕確認功能。(如下圖) 然後畫面會自動跳至溫度選項。



2. 按旋鈕確認溫度 60°C 的設定。(如下圖) 然後畫面會自動跳至小時選項。

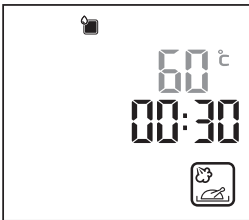

3. 按旋鈕確認小時位 00 設定。(如下圖) 然後畫面會自動跳至分鐘選項。





4. 轉動旋鈕直到顯示分鐘轉至 40，按旋鈕確認。(如下圖)



5. 設置完成，開始烹調。(如下圖)



烹調結束時，顯示屏會顯示“END”並發出聲效，提示操作已完成。

同時顯示屏上  增加烹調時間圖示(在烹調結束後，客人可按需要追加烹調時間)和  清除接水盤提示圖示(提示客人有可能需要清除接水盤的水)會閃爍。

操作方法說明

■ 乾果模式

以低溫熱風抽乾食物，適合製作各種生果片，蔬菜片或肉乾。

	溫度	時間
開機預設	80°C	60 分鐘
設定範圍	40°C - 90°C	5 分鐘 - 12 小時 59 分鐘

例如：設置烹調時間為 2 小時，溫度為 90°C。

操作步驟：

1. 在待機狀態下，順時針旋轉旋鈕至  乾果模式圖示閃爍，按旋鈕確認功能。(如下圖) 然後畫面會自動跳至溫度選項。

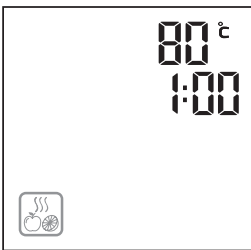

2. 轉動旋鈕直到顯示溫度轉至 90°C，按旋鈕確認。(如下圖) 然後畫面會自動跳至小時選項。

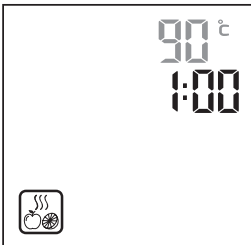

3. 轉到旋鈕直至顯示小時轉至 02，按旋鈕確認。(如下圖) 然後畫面會自動跳至分鐘選項。

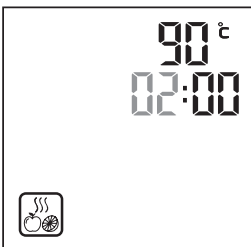

4. 按旋鈕確認分鐘位 00 設定。(如下圖)

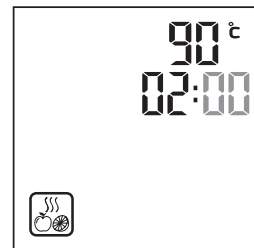

5. 設置完成，開始烹調。(如下圖)

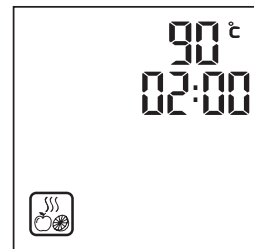

烹調結束時，顯示屏會顯示“END”並發出聲效，提示操作已完成。

同時顯示屏上  增加烹調時間圖示 (在烹調結束後，客人可按需要追加烹調時間) 會閃爍。

操作方法說明

■ 解凍模式

以蒸氣去解凍冷藏或冷凍食物。每次使用前，請確保水箱已加滿水。

	溫度	時間
開機預設	55°C	30 分鐘
設定範圍	50°C - 60°C	5 分鐘 - 6 小時 59 分鐘

例如：設置烹調時間為 1 小時 40 分鐘，溫度為 60°C。

操作步驟：

1. 在待機狀態下，順時針旋轉旋鈕至  解凍模式圖示閃爍，按旋鈕確認功能。(如下圖) 然後畫面會自動跳至溫度選項。



2. 轉動旋鈕直到顯示溫度轉至 60°C，按旋鈕確認。(如下圖) 然後畫面會自動跳至小時選項。



3. 轉動旋鈕直至顯示小時轉至 01，按旋鈕確認。(如下圖) 然後畫面會自動跳至分鐘選項。

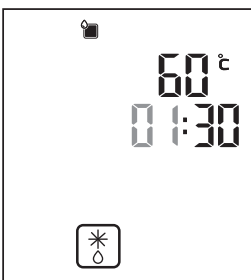

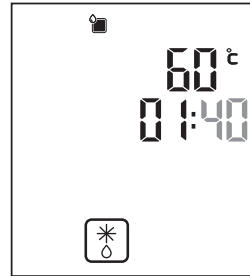

4. 轉動旋鈕直到顯示分鐘轉至 40，按旋鈕確認。(如下圖)

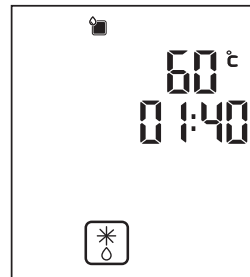

5. 設置完成，開始烹調。(如下圖)



烹調結束時，顯示屏會顯示“END”並發出聲效，提示操作已完成。

同時顯示屏上  增加烹調時間圖示(在烹調結束後，客人可按需要追加烹調時間)和  清除接水盤提示圖示(提示客人有可能需要清除接水盤的水)會閃爍。

■ 預熱 - 蒸氣模式

預熱蒸氣模式，使爐腔達至預設溫度。

溫度	
開機預設	100 °C
設定範圍	50 °C - 110 °C

預熱功能的烹調時間均毋需設定；當達到設定的預熱溫度時，顯示屏會顯示“END”和發出聲效，提示操作已完成。

例如：以蒸氣進行預熱，設置烹調溫度為 100 °C。

操作步驟：

1. 在待機狀態下，順時針旋轉旋鈕至  預熱蒸氣模式圖示閃爍，按旋鈕確認功能。(如下圖)



2. 此時自動進入烹調溫度的設置；按旋鈕確認預設溫度 100 °C 的設定。(如下圖)



3. 設置完成，開始預熱。(如下圖)

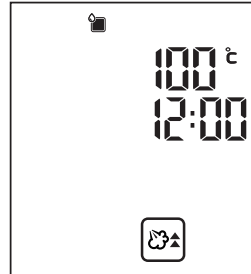

預熱結束時，顯示屏會顯示“END”及發出聲效，提示操作已完成。同時顯示屏  清潔接水盤提示圖示(提示客人有可能需要清除接水盤的水)會閃爍。(如下圖)預熱完成後，客人可以根據需要，選擇其他烹調模式進行烹調。

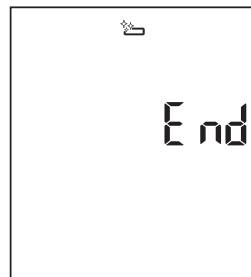

注意：“結束後追加時間功能”功能不適用於此模式。

操作方法說明

■ 預熱 - 烤焗模式

預熱烤焗模式，使爐腔達至預設溫度。

溫度	
開機預設	180 °C
設定範圍	100 °C - 230 °C

預熱功能的烹調時間均毋需設定；當達到設定的預熱溫度時，顯示屏會顯示“END”和發出聲效，提示操作已完成。

例如：以烤焗進行預熱，設置烹調溫度為 200 °C。

操作步驟：

1. 在待機狀態下，順時針旋轉旋鈕至  預熱烤焗模式圖示閃爍，按旋鈕確認功能。(如下圖)

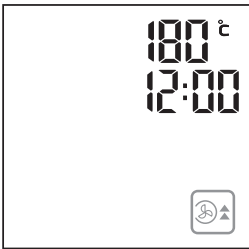

2. 此時自動進入烹調溫度的設置；轉動旋鈕直到顯示溫度轉至 200 °C，按旋鈕確認。(如下圖)

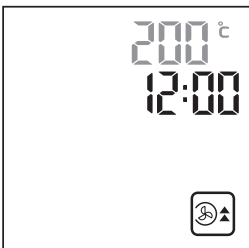

3. 設置完成，開始預熱。(如下圖)

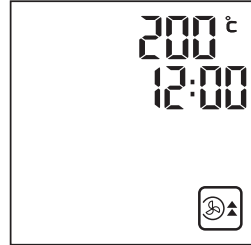

預熱結束時，顯示屏會顯示“END”及發出聲效，提示操作已完成(如下圖)。預熱完成後，客人可以根據需要，選擇其他烹調模式進行烹調。



注意：“結束後追加時間功能”不適用於此模式。

操作方法說明

■ 保溫模式

以熱風保溫食物，適合將剛煮的食物保溫。

	溫度	時間
開機預設	55°C	30 分鐘
設定範圍	50°C - 60°C	5 分鐘 - 3 小時 59 分鐘

例如：設置烹調時間為 1 小時 30 分鐘，溫度為 60°C。

操作步驟：

1. 在待機狀態下，順時針旋轉旋鈕至  保溫模式圖示閃爍，按旋鈕確認功能。(如下圖) 然後畫面會自動跳至溫度選項。



2. 轉動旋鈕直到顯示溫度轉至 60°C，按旋鈕確認。(如下圖) 然後畫面會自動跳至小時選項。

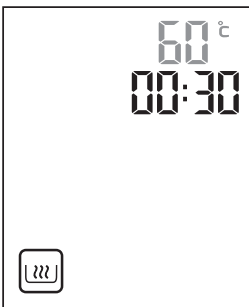

3. 轉動旋鈕直至顯示小時位轉至 01，按旋鈕確認。(如下圖) 然後畫面會自動跳至分鐘選項。

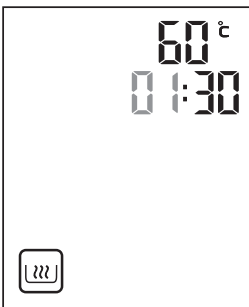

4. 按旋鈕確認分鐘位30的設定。

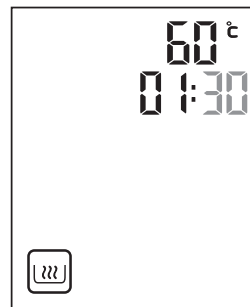

5. 設置完成，開始烹調。(如下圖)



烹調結束時，顯示屏會顯示“END”並發出聲效，提示操作已完成。
同時顯示屏上  增加烹調時間圖示 (在烹調結束後，客人可按需要追加烹調時間) 會閃爍。

操作方法說明

■ 烘乾爐腔模式

此模式會以高溫加熱爐腔，蒸發爐腔中多餘水份及蒸氣。此功能適用於任何以蒸氣烹調的模式後使用。

	溫度	時間
開機預設	230 °C	25 分鐘
設定範圍	不可調校	不可調校

操作步驟：

1. 在待機狀態下，順時針旋轉旋鈕至  烘乾爐腔模式圖示閃爍，按旋鈕確認功能。(如下圖)



2. 開始烹調。(如下圖)

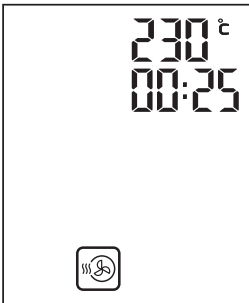

烹調結束時，顯示屏會顯示“END”並發出聲效，提示操作已完成。同時顯示屏上  增加烹調時間圖示 (在烹調結束後，客人可按需要追加烹調時間) 會閃爍。

注意：“烹調過程中調校”功能不適用於此模式。

操作方法說明

■ 消毒模式

以 110°C 高溫蒸氣消毒，可消毒餐具或嬰兒奶瓶等。每次使用前，請確保水箱已加滿水。

	溫度	時間
開機預設	110°C	30 分鐘
設定範圍	不可調校	5 分鐘 - 6 小時 59 分鐘

例如：設置烹調時間為 35 分鐘。

操作步驟：

1. 在待機狀態下，順時針旋轉旋鈕至  消毒模式圖示閃爍，按旋鈕確認功能。(如下圖) 然後畫面會自動跳至小時選項。

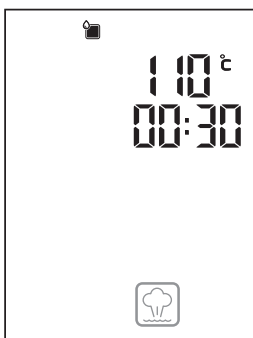

2. 按旋鈕確認小時位 00 設定。(如下圖) 然後畫面會自動跳至分鐘選項。





3. 轉動旋鈕直到顯示分鐘轉至 35，按旋鈕確認。(如下圖)

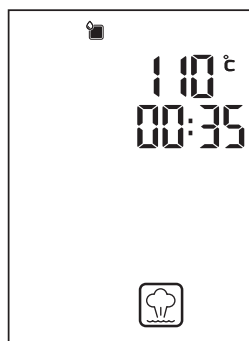

4. 設置完成，開始烹調。(如下圖)





烹調結束時，顯示屏會顯示“END”並發出聲效，提示操作已完成。

同時顯示屏上  增加烹調時間圖示(在烹調結束後，客人可按需要追加烹調時間)和  清除接水盤提示圖示(提示客人有可能需要清除接水盤的水)會閃爍。

■ 除垢模式

長期使用蒸氣功能會導致機內及水管內產生水垢。

當累積使用蒸氣模式或其他帶有蒸氣功能模式的時間達到 100 個小時，顯示屏上  除垢提示圖示會亮起，提醒用戶進行除垢模式。直至用戶啟動除垢模式後，圖示才會熄滅。

除垢模式分 3 個階段，分別進行 1 次除垢和 2 次除垢清潔。在整個除垢過程中，需要更換水箱內的液體 3 次，並需要倒掉接水盤內的污水。當需要倒掉接水盤內的污水時，顯示屏上  會相應亮起來提醒用戶。

除垢模式需配合除垢劑使用。客人可選用惠而浦獨家推出的Wpro除鈣去垢劑，此產品適用於蒸爐，有效清空蒸爐管道內的鈣化聚積物和保持機器良好的操作性能。詳情可到惠而浦(香港)有限公司網站www.whirlpool.com.hk了解。

進行除垢模式時，建議使用除垢劑和淨水分量如下：

第 1 階段：除垢，時間為 30 分鐘。建議使用 10 毫升除垢劑和 120 毫升淨水。



第 2 階段：第 1 次除垢清潔，時間為 10 分鐘。建議使用 130 毫升淨水。

第 3 階段：第 2 次除垢清潔，時間為 10 分鐘。建議使用 130 毫升淨水。

	溫度	時間
開機預設	85°C	50 分鐘
設定範圍	不可調校	不可調校

操作步驟：

1. 第 1 個階段：除垢

- 先將 10 毫升除垢劑和 120 毫升淨水倒入水箱至水箱上130毫升  除垢圖標位置。
- 在待機狀態下，順時針旋轉旋鈕至  除垢模式圖示閃爍，按旋鈕確認功能。(如下圖)

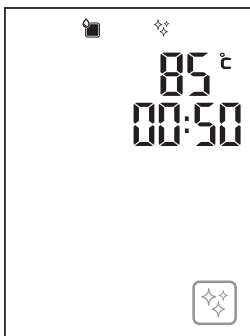



C. 開始除垢模式。(如下圖)





- 第 1 個階段需時 30 分鐘，程式完成後，顯示屏上的時間位會閃動，並發出聲效去提示第 1 個階段完成。同時顯示屏上  清潔接水盤圖示會閃爍，提醒用戶倒掉接水盤內的污水。
- 請倒掉污水，並裝回接水盤。

2. 第 2 個階段：第 1 次除垢清潔

- 打開爐門，將 130 毫升淨水倒入水箱至水箱上130毫升  除垢圖標位置。
- 將水箱放回機內並關上爐門，程式會自動啟動，繼續除垢清潔工作。
- 第 2 個階段完成後，顯示屏上的時間位會閃動，並發出聲效提示第 2 個階段完成，同時顯示屏上  清潔接水盤圖示會閃爍，提醒用戶倒掉接水盤內的污水。
- 請倒掉污水，並裝回接水盤。

操作方法說明

3 第3個階段：第2次除垢清潔

- A. 打開爐門，將 130 毫升淨水倒入水箱至水箱上130毫升  除垢圖標位置。
- B. 將水箱放回機內並關上爐門，程式會自動啟動，繼續除垢清潔工作。
- C. 第 3 個階段完成後，顯示屏會顯示“End”提示，並發出聲效提示，同時顯示屏上  清潔接水盤圖示會閃爍，提醒用戶倒掉接水盤內的污水。
- D. 請倒掉污水，並裝回接水盤。

4. 除垢完成。

注意：1. “烹調過程中調校 / 結束後追加時間” 功能不適用於此模式。

- 2. 除垢過程中，如操作有誤（包括操作過程中按暫停或沒有按指示下開關爐門等），除垢模式程式會被擾亂而無法正常運作。建議重新啟動除垢模式並按照除垢模式中的指示再次操作。

■ 預約功能

在進行預約功能設定前，必須先完成時鐘設定。時鐘設定可參見本說明書第 13 頁“設置時鐘”內說明。例如：現時時間為 16:30，設置預約底部燒烤模式，烹調時間為 40 分鐘，溫度為 210°C，結束時間為 18:00。

操作步驟：

1. 在待機狀態下，順時針旋轉旋鈕至  底部燒烤模式圖示閃爍，按旋鈕確認功能。(如下圖) 然後畫面會自動跳至溫度選項。



2. 轉動旋鈕直到顯示溫度轉至為 210°C，按旋鈕確認。(如下圖) 然後畫面會自動跳至小時選項。

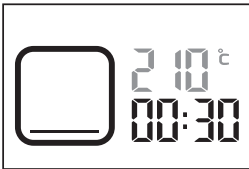

3. 按旋鈕確認小時位00設定。(如下圖) 然後畫面會自動跳至分鐘選項。

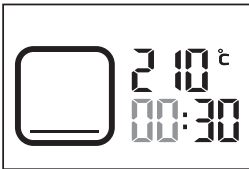

4. 轉動旋鈕直到顯示分鐘轉至 40，按設置鍵  確認。(如下圖)



5. 此時畫面會進入預約烹調結束時間的小時位設置，時鐘位顯示的時間會切換回現時的時間 16:30，小時位“16”會閃爍；同時，顯示屏上方  預約功能圖示會閃爍，表示正在進行預約功能設定。(如下圖)



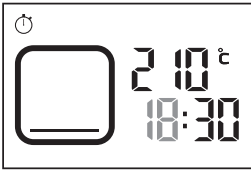

操作方法說明

6. 轉動旋鈕直到小時位轉至 18，按旋鈕確認。(如下圖) 然後畫面會自動跳至分鐘選項。



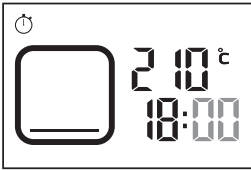

7. 轉動旋鈕直到顯示分鐘轉至 00，按旋鈕確認。

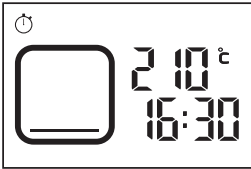

8. 顯示屏上  預約功能圖示會亮起，預約烹調時間切換回現時時間 16:30。表示預約設置完成。(如下圖)



A. 查詢預約狀態

可按設置鍵  3 秒，以查詢預約結束時間，預約功能圖示會閃爍顯示；再按設置  3 秒，可返回預約設置畫面。

B. 取消預約設定：

如需取消預約設定，可直接按  電源鍵，即退出預約設定，並自動返回到待機畫面。

注意：預約模式適用於 9 個主要烹調模式，翻熱中式包點模式，翻熱西式麵包模式，慢煮模式和乾果模式。
(詳情請參閱第 9-11 頁控制面板 - 主要功能介紹 / 主要功能詳細說明)

建議：預約設置後，可啟動兒童安全鎖功能，以防止不小心觸摸到控制面板而誤將預約取消。童鎖設置可參見本說明書第 8 頁“控制面板 - 基本功能說明”內說明。當達到預約的啟動時間，蒸焗爐會正常啟動，不受童鎖影響。

■ 烹調過程中調校 / 結束後追加時間功能

A. 烹調過程中進行調校



在烹調過程中，可以根據需要去增加或減少烹調時間和溫度。

例如：已設定的烹調時間 01:40 和溫度 90°C，改為烹調時間 02:00 及溫度 100°C。

操作步驟：

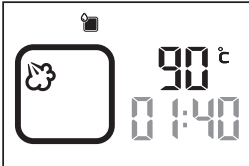
1. 於烹調過程中，按旋鈕暫停烹調，時間位會閃爍。(如下圖)



2. 按設置鍵  自動進入調較設置，溫度位會閃爍；顯示屏上  烹調過程中調校圖示會亮起。(如下圖)

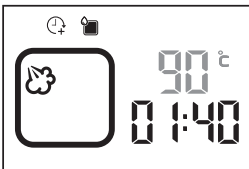

3. 轉動旋鈕直到顯示溫度轉至 100°C，按設置鍵  確認。(如下圖) 然後畫面會自動跳至小時選項。

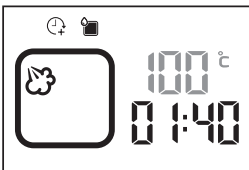

4. 轉動旋鈕直到顯示小時轉至 02，按設置鍵  確認。(如下圖) 然後畫面會自動跳至分鐘選項。

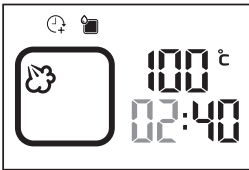

5. 轉動旋鈕直到顯示分鐘轉至 00，按旋鈕確認。(如下圖)

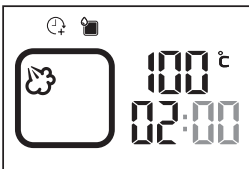

6. 設置完成，開始新設置的烹調設定。(如下圖)

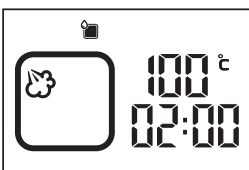



操作方法說明

B. 烹調結束後追加時間功能

烹調結束後，可以根據需要去增加烹調時間。

	溫度	時間
設定範圍	不可調校	1 分鐘 - 59 分鐘

烹調結束後，顯示屏會顯示“End”並發出聲效提示。同時顯示屏上  結束後追加時間圖示會閃爍。
 清潔接水盤提示圖示會閃爍約 3 分鐘（註：清潔接水盤提示圖示只會在使用蒸氣相關功能後才亮起）。
（如下圖）



如增加烹調時間，可根據以下步驟操作：

例如：烹調結束後，追加烹調時間 3 分鐘。

操作步驟：

1. 按旋鈕確認追加時間功能，顯示屏會自動跳至分鐘位選項。（如下圖）

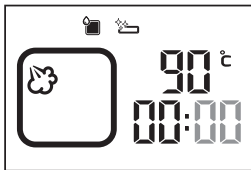

2. 轉動旋鈕直到顯示分鐘轉至 03，按旋鈕確認。（如下圖）

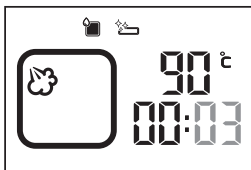

3. 設置完成，即啟動追加時間烹調。（如下圖）

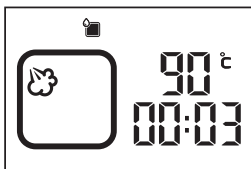

注意：如果用戶在烹調結束後，5 分鐘內沒有進行任何操作，將自動返回到待機狀態。

■ 餘溫高溫提示 H

在待機狀態或省電模式狀態下，完成煮食後，只要爐腔內的溫度高於 50°C，顯示屏上 H 高溫提示圖標就會亮起，提醒用戶爐腔內溫度較高，不適宜進行清潔（如下圖）。直到爐腔內的溫度低於 50°C，顯示屏上高溫提示圖標才會消失，建議用戶於圖示消失後才進行清潔。



■ 童鎖功能

用來鎖住按鍵，防止兒童在沒有成人指導的情況下使用蒸焗爐。

A. 啟動童鎖：

可長按  童鎖鍵 3 秒鐘，進入童鎖狀態，此時顯示屏上方的童鎖圖示亮起。（如下圖）

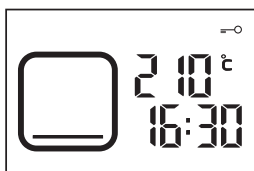

B. 解除童鎖

長按  童鎖鍵 3 秒鐘，即可解除童鎖，此時顯示屏上方的童鎖圖示會消失。

■ 清潔保養

1. 在正常情況下，清潔產品是唯一所需的保養方法。
2. 請務必在蒸焗爐冷卻狀態下，H 圖示消失後進行清潔與保養。清潔之前，需切斷電源。請勿使用蒸氣清潔器清洗本蒸焗爐。
3. 蒸焗爐必須保持清潔，否則可能導致爐身受到腐蝕，縮短蒸焗爐的使用壽命，所以每次使用蒸焗爐後，必須進行清潔。
4. 切勿使用含金屬成份的清潔布、磨砂型潔具、鋼刷、表面粗糙的抹布，否則會對爐身表面、爐門、控制面板、爐內壁及配件造成損害。應以沾有溫和洗潔精的海綿或軟布或噴上玻璃清潔劑的廚房紙巾進行清潔。每次使用後，確保爐腔（包括爐腔底部）是乾透。
5. 鹽份是具侵蝕性的物質，一旦積聚在爐腔內，將形成鏽漬。一些帶酸性的醬汁，例如茄汁、芥末和醃製食品含有氯和酸的化學成份。而該等成份會對鋼表面造成影響。所以建議每次使用蒸焗爐後，必須進行清潔。
6. 切勿讓油脂及食物碎屑殘留於爐門及爐門封邊上。假如爐門封邊清潔處理不善，或會影響蒸焗爐操作時，爐門無法完全關上，繼而導致機前方及兩側部份損壞。
7. 每次使用後，
 - i) 清理蒸焗爐門底下的黑色接水盤的積水，以防止積水滿瀉，濺濕及弄髒檯面。（接水盤是可以拆下的。它會盛載每次蒸煮後玻璃門開門時滴下的倒汗水。）
 - ii) 清理殘留在水箱未用完的水。
 - iii) 每次使用後，打開爐門 15-30 分鐘或進行烘乾爐腔模式，以風乾爐腔及門框。
8. 如果爐腔非常骯髒，可於清潔前，先以「消毒模式」（110°C），蒸煮 30 分鐘，來溶解油漬，待機身冷卻後，才開始進行清潔。如遇上頑固的油漬，可重覆以上的步驟。切勿使用含金屬成份的清潔布、磨砂型潔具、鋼刷、表面粗糙的抹布清潔。
9. 建議最少每一個月或除垢圖示亮起時進行“除垢模式”清潔。
10. 建議使用直接從水喉取的自來水、飲用食水或蒸餾水作烹調用，但避免使用礦泉水。
11. 水箱必須每月至少檢查一次。如有需要，取出水箱，擦洗乾淨後再放回原處。
12. 若長時間不使用本產品時，應拔掉電源插頭，保持爐腔清潔，並將蒸焗爐放置在通風、乾燥及沒有腐蝕性氣體的環境中。
13. 每次使用後，應清潔和風乾爐腔（包括爐腔頂部，左右兩側和底部）。如爐底或爐腔有變黃的情況，可以使用不鏽鋼清潔劑去除污漬。（例如：Wpro 不鏽鋼清潔劑）

■ 如何拆下上發熱管

1. 用拇指向後按壓發熱管彈片尖端至彈片邊緣，把固定發熱管的鋼架拉下，如下圖箭頭所示位置；

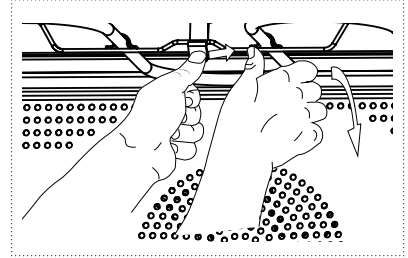
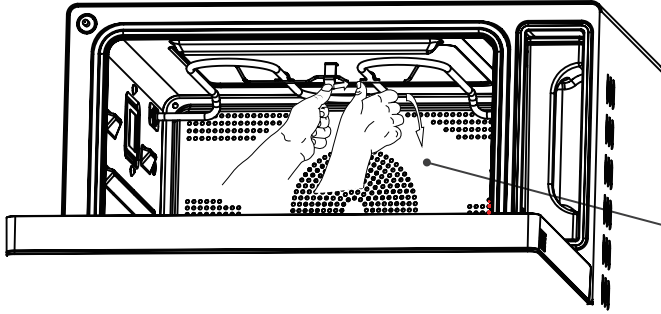

用拇指向後按壓發熱管彈片尖端至彈片邊緣，把固定發熱管的鋼架拉下。

2. 即可對爐腔頂部進行清潔；(如下圖)

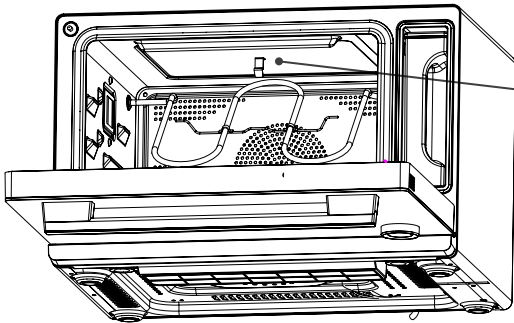

發熱管移向下後，方便對爐腔頂部進行清潔。

3. 清潔完成後，將上發熱管稍微向上壓，扣回上發熱管的固定件。

注意：1. 在扣合的時候，用雙拇指並需要稍微向上壓，以便鋼架扣位更加容易扣回固定件。
2. 需確保爐腔冷卻， 圖標消失後，才進行清潔。

■ 故障排解

A. 如出現以下情況

	如以下情況出現...	可能成因	解決方法
1	顯示屏上顯示消失	蒸焗爐沒有連接到電源	確保蒸焗爐連接電源
		插座有問題	用其他電器再測試插座是否有問題
		電源線不能正常工作	與客戶服務部聯絡
2	蒸焗爐不能操作	電源插頭沒有插好	重新插好電源插頭
		爐門沒有關好	重新關閉爐門
		水箱沒有放置妥善	重新放回水箱並妥善安裝
		電路版損壞	與客戶服務部聯絡
		兒童安全鎖被鎖住	解除兒童安全鎖
3	顯示屏顯示異常	顯示屏損壞	與客戶服務部聯絡
		電路板損壞	
4	烹調期間大量排出水或蒸氣	爐門沒有關上	重新把爐門關上
		爐門封邊損壞	與客戶服務部聯絡
5	爐燈不亮	爐燈損壞	與客戶服務部聯絡
		主機電腦板損壞	
6	風扇不能正常運作	風扇電機損壞	與客戶服務部聯絡
		主機電腦板損壞	
7	按鍵失靈	按鍵損壞	與客戶服務部聯絡
		主機電腦板損壞	
8	無蒸氣噴出	水管被折疊、堵塞或損壞	與客戶服務部聯絡
		水泵損壞	
9	蒸焗爐漏水	沒有把儲水箱完整推進到位	請將水箱加滿水並妥善安裝

其他須知

B. 下列情況均屬正常

如以下情況出現...		
1	首次使用各種燒烤或烤焗模式時，蒸焗爐有少量白煙冒出及異味。	這是由蒸焗爐內的保護部件有油脂揮發所引起的。這屬於正常現象，非損壞。
2	使用蒸氣相關功能時有聲音	水箱吸水時或會混入空氣造成聲音，是正常現象。
3	蒸氣凝結在出風口	使用與蒸氣相關的功能時，蒸焗爐運轉過程中爐腔內會產生大量蒸氣，爐腔內多餘的蒸汽會通過出風口排出，但少部分蒸汽由於環境溫度，會凝結在出風口處，這是正常現象。
4	烹調結束後風扇仍在工作	某些烹調程式結束後，風扇會延時工作 3 分鐘，將腔體內的熱量排出。這是產品冷卻爐腔和電子元件，屬於正常現象。
5	如發現有白色粉末在入氣口流出	這是水垢，是正常現象。如發現白色粉末 (水垢)，請啟動除垢模式，以清潔水管。
6	如爐腔 / 爐底有變黃現象	不鏽鋼受熱後，如清潔處理不善，會產生變黃現象。建議每次使用蒸焗爐後，進行清潔以避免變黃現象產生。
7	烹調過程中或完成後關門時有聲音	這是由於爐腔與室溫壓力差異所致。這屬於正常現象，非損壞。
8	關門時有水在出風口溢出	這是由於爐腔與室溫壓力差異所致。這屬於正常現象，非損壞。

■ 產品規格

型號	CS1252A / CS1252B
額定電壓及額定頻率	220-240V ~ 50/60Hz
額定輸入功率	2100W
產品尺寸(高 × 闊 × 深)	330 x 500 x 441 毫米
爐腔尺寸(高 × 闊 × 深)	220 x 366 x 309 毫米
爐腔容積	25公升
淨重	約 17 公斤

Table of Contents

■ General Preparation and Advice before Use	Page
Important Safety Information	45
Precautions before First Use	45
Precautions and Advice	45-46
Mounting the Appliance	47
Earthing Instructions	48
Appliance and Accessories Chart	48-49
Control Panel	50
Control Panel – Basic Functions	51
Control Panel – Major Features	52
Control Panel – Description of Major Features	53-55
Use and Cooking Tips	56

■ Operation Instructions	Page
Setting the Clock	57
Steam Mode	58
Forced Air + Steam Mode	59
Upper/Bottom Grill/Conventional Bake Mode	60
Forced Air Mode	61
Convection Mode	62
Air Fry Mode	63
Convection + Steam Mode	64
Proving Mode	65
Bun Reheat Mode	66
Bread Reheat Mode	67
Slow Cook Mode	68
Drying Fruit Mode	69
Defrost Mode	70
Preheat - Steam Mode	71
Preheat - Baking Mode	72
Keep Warm Mode	73
Cavity Drying Mode	74
Sterilization Mode	75
Descaling Mode	76-77
Preset Function	78-79
Adjust the setting during Cooking Process / Increase the Cooking Time after Cooking is Completed	80-81
Residual Heat Indicator	82
Child Lock	82

■ Cleaning and Maintenance	Page
Cleaning and Maintenance	83
How to Lower the Upper Heater	84

■ Others	Page
Troubleshooting	85-86
Product Specifications	87

General Preparation and Advice before Use

■ Important Safety Information

This manual contains important information on safety, use and maintenance of the product. Please read the manual carefully and keep it in an easily accessible place for future reference.

■ Precautions before First Use

1. Two or more people are required to install or move this appliance as it is heavy. It must be securely placed on a firm and level surface. Failure to do so can cause physical injuries or damage to the appliance.
2. This appliance is designed solely for indoor and domestic use. Follow the cooking instructions indicated in the manual. Do not use this appliance for outdoor, commercial or any other purposes.
3. Check that the voltage on the rating label corresponds to the voltage in your home.
4. Ensure that the appliance is not damaged. Do not operate the appliance if it has a damaged mains cord or plug. If it is not working properly, or it has been damaged or dropped. Please contact Whirlpool Customer Services.
5. Do not immerse the power cord or plug in water. Keep the power cord away from hot surfaces to avoid electrical shock, fire or other accidents.
6. This combi steamer is designed for free standing installation. Do not install as a built-in appliance.
7. Allow adequate ventilation space on all sides and do not place any object on top. Keep a minimum distance of 30cm between the combi steamer and any overhead wall cabinet; and a minimum distance of 5cm between both sides of the appliance and the walls.
8. To avoid damage to the appliance, do not block the ventilation vent.
9. Run the "Sterilization Mode" for 30 minutes to clean and sterilize the combi steamer before first use.
10. The manufacturer disclaims all liability for faults arising from improper use of this appliance.
11. Steam is emitted from the top ventilation vent. Blocking the outlets will result in damage to the combi steamer.
12. Use heat resistant utensils for cooking, such as heat resistant glass and heat resistant plastic. Non-heat

resistant containers should not be used with combi steamer. For steaming functions, container with heat resistant >120°C should be used. For convection functions, container with heat resistant >250°C should be used.

13. Odour will be emitted from the cavity when using different baking functions for the first time. It is normal.

■ Precautions and Advice

1. Stop using the combi steamer and contact Whirlpool Customer Service immediately if the door or door seal is damaged.
2. If the power cord is damaged, it must be replaced by the manufacturer, its service agent or similarly qualified persons in order to avoid a hazard.
3. To avoid fire hazard or explosion, do not heat or use flammable materials in or near the appliance.
4. To avoid fire hazard, do not use the appliance to dry cloth, paper, spices, herbs, wood, flowers or other flammable objects.
5. Overcooking food poses a fire hazard.
6. Never leave the appliance unattended during use, particularly when cooking with paper, plastic or other flammable materials. Paper may catch fire or get burned and some plastic materials may melt when heating up food with the appliance. If any object inside or outside the appliance is ignited or emits smoke, close the appliance door and switch off the combi steamer. Disconnect the power supply and the socket with circuit leakage breaker.
7. This combi steamer is specifically designed to heat or cook food. It is not designed for industrial or laboratory used.
8. This combi steamer is not intended for use by persons (including children) with reduced physical, sensory or mental capabilities, or lack of experience and knowledge, unless under supervision or instruction of a person responsible for their safety.
9. After cooking, clean the combi steamer only when it has completely cooled down. Wipe away any food debris or waste inside the oven. Top of the oven cavity gets burned easily and care should be taken to keep it clean. For best cooking results, keep the combi steamer completely dry by opening the door every time after cooking.

General Preparation and Advice before Use

10. Use oven gloves to take food and containers out of the appliance to avoid burning.
11. To avoid a hazard, do not touch the upper heater in the oven when using the appliance.
12. Do not use the combi steamer for storage.
13. After heating food or beverages in nursing bottles or infant food cans, always stir and check the temperature before serving. This will ensure that heat is evenly distributed and the risk of scalding or burns can be avoided.
14. Wait 10-15 minutes after each program before continuing to another mode.
15. Steam will be rapidly evaporated and not easily seen if the oven cavity at the high temperature or just finished all convection modes. It is normal.
16. Do not touch the door and door frame when using the appliance.
17. Fill the water tank with tap water, drinking water or distilled water up to the MAX mark (maximum level). Insert the water tank into the appliance completely until it clicks to ensure it is fixed in the right position.
18. If the water tank is cracked or damaged, stop using it to avoid power leakage or electrical shock caused by water leakage.
19. For hygienic reasons and to prevent condensation inside the combi steamer, empty the water tank and keep the combi steamer completely dry every time after cooking.
20. Do not fill the water tank with any liquids other than water (except descaler).
21. To avoid condensation and oven temperature drops, do not open the oven door when cooking with "Steam" mode unless it is absolutely necessary. If you have opened the oven door, extend the cooking time accordingly.
22. If it is necessary to open the oven door to turn the food or for other purposes during cooking, keep a distance from the oven door (particularly the face) to prevent scalding.
23. All maintenance and repairs should be carried out by a similarly qualified person. It is dangerous to fix the appliance by anyone except a similarly qualified person. Never dismantle, repair or modify the appliance by yourself.
24. Accessible parts of the appliance may become hot during use. Young children should be kept away.
25. When combi steam is plugged, never touch the appliance, the power cord or plug with wet hands or other wet body parts.
26. Do not place or hang any objects on the oven door or the door handle. It may affect the door's opening and closing or damage the door hinges.
27. After cooking ends of certain cooking programs, the electric fan will continue running for a certain period of time to cool down the cavity.
28. The combi steamer and its parts should be kept clean. Failure to do so will result in deterioration of the appliance surface and affect its life cycle. It may also cause danger.
29. Remove the power supply plug before cleaning. Do not use corrosive cleaners as they may cause damage or corrosion.
30. Water in the water tank will be heated up and discharged to the drip tray during "Descaling Mode". Do not allow children to touch or go near the combi steamer.
31. Remove the power supply plug before cleaning the cavity.
32. Clean dust from the power supply plug on a regular basis. If the product will not be used for a long time, remove the power supply cord. Do not pull the power supply cord but hold the plug to remove it.
33. Never leave the combi steamer in operation unattended.
34. Overheated fat and oil catch fire easily. Except grilling meat, heating oil during cooking is dangerous. Such practice should never be allowed.
35. Maximum load for the oven door is 4.5kg. To avoid damaging the combi steamer, do not place food or heavy objects on the oven door.
36. Please do not block the door sensor, otherwise it may cause accidents and fire.
37. This appliance is not intended to be operated by means of an external timer or separate remote-control system.
38. Water tank may become hot during the cooking process or after cooking is completed.
39. Children should be supervised to ensure that they do not play with the appliance.



Caution: Hot Surface !

General Preparation and Advice before Use

■ Mounting the Appliance

1. Good ventilation must be ensured around the combi steamer. Do not place any objects on top of the appliance and allow a minimum distance of 30cm between the combi steamer and any overhead wall cabinet. Keep a minimum distance of 5cm between both sides of the appliance and walls. Appliance back can be closed to the wall.

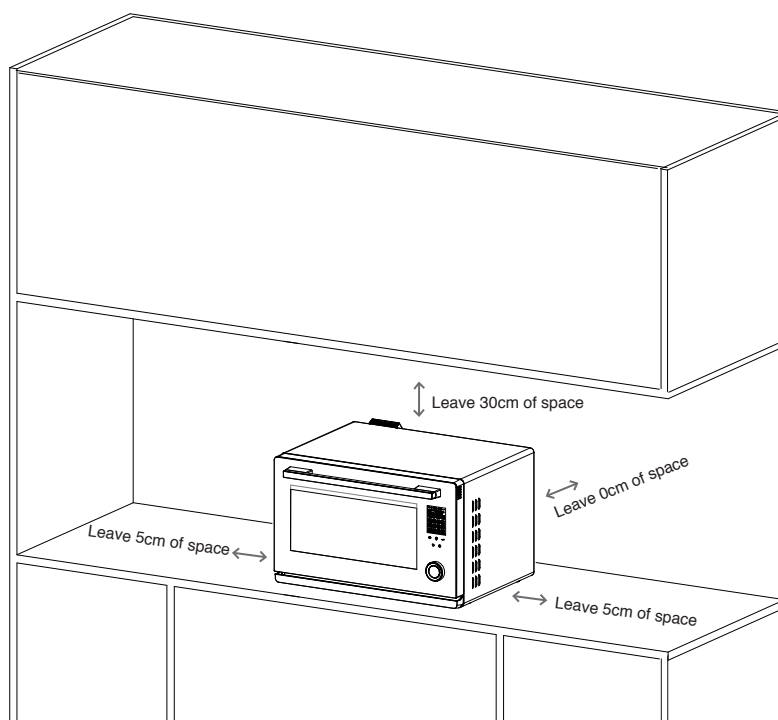

2. To prevent fire, do not block the air outlet and steam outlet. Maintain the product regularly and prevent foreign matter and dust from blocking the air outlet and steam outlet.
3. Do not put the appliance in a hot or humid place, such as gas stove, electrified areas or sink.
4. This appliance must be placed on a firm and stable surface.

General Preparation and Advice before Use

■ Earthing Instructions

This appliance must be earthed. In case of electric leakage, the ground can provide a current loop to avoid electric shock. The power supply plug that comes with this appliance must be inserted into a single-phase-bipolar socket with grounding.

■ Appliance and Accessories Chart

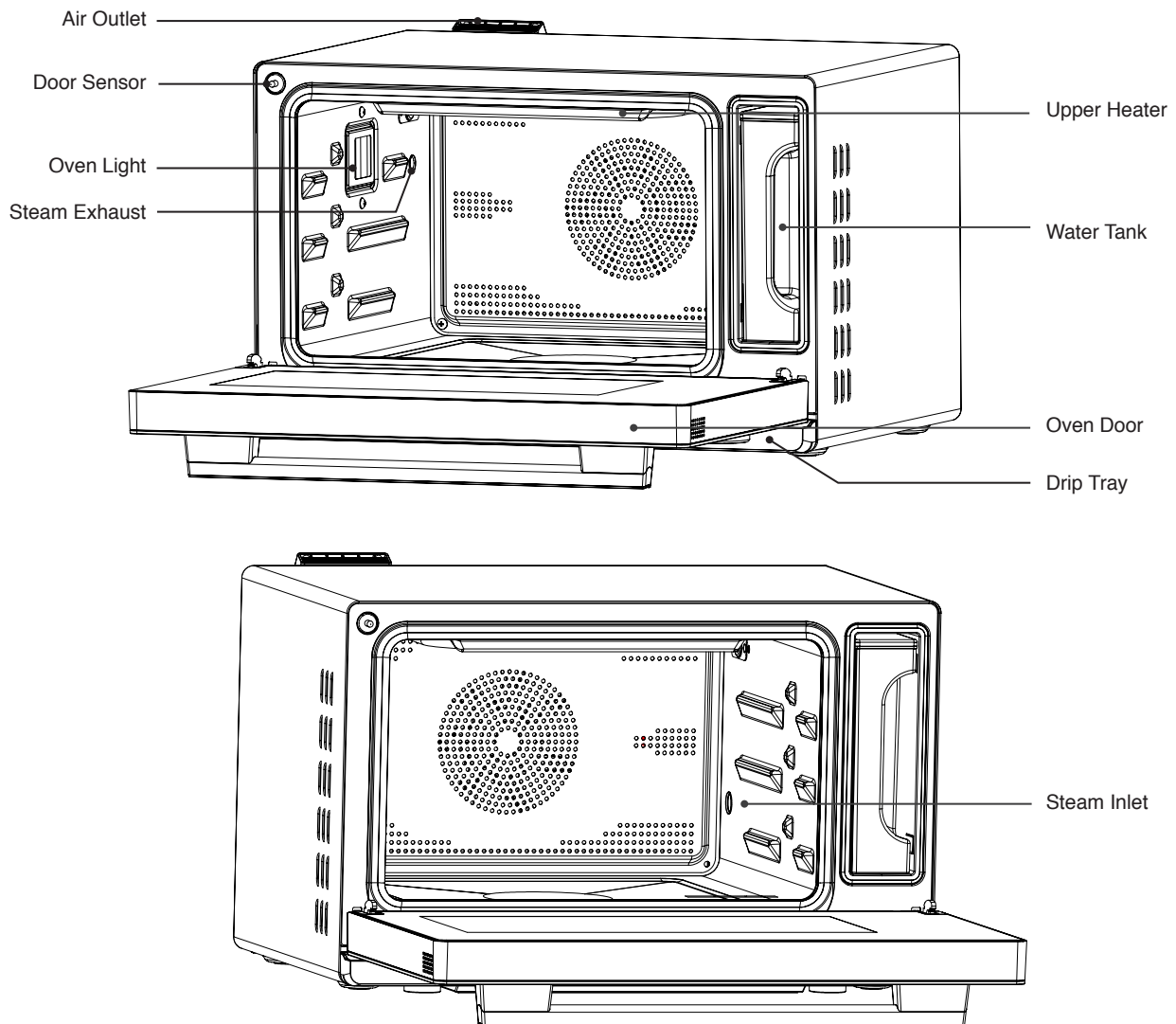

1. Control Panel: To operate the combi steamer (For details see the control panel instructions P.51-55).
2. Air Outlet: To exhaust excessive steam from the cavity.
3. Oven Light: To light up the oven to observe the food being cooked.
4. Steam Exhaust: To discharge excess steam from the cavity.
5. Upper Heater: To generate heat to cook food.
6. Water Tank: To be filled with water to generate steam.
7. Steam Inlet: To release steam into the cavity.
8. Oven Door:
 1. Make sure the door is closed before starting to cook.
 2. The combi steamer will pause if you open the oven door during cooking. The selected mode will continue automatically once the door is closed.
9. Drip Tray: To collect excess water when the door is open and foul water from Descaling Mode.
10. Door Sensor: To sense the door closed.

General Preparation and Advice before Use

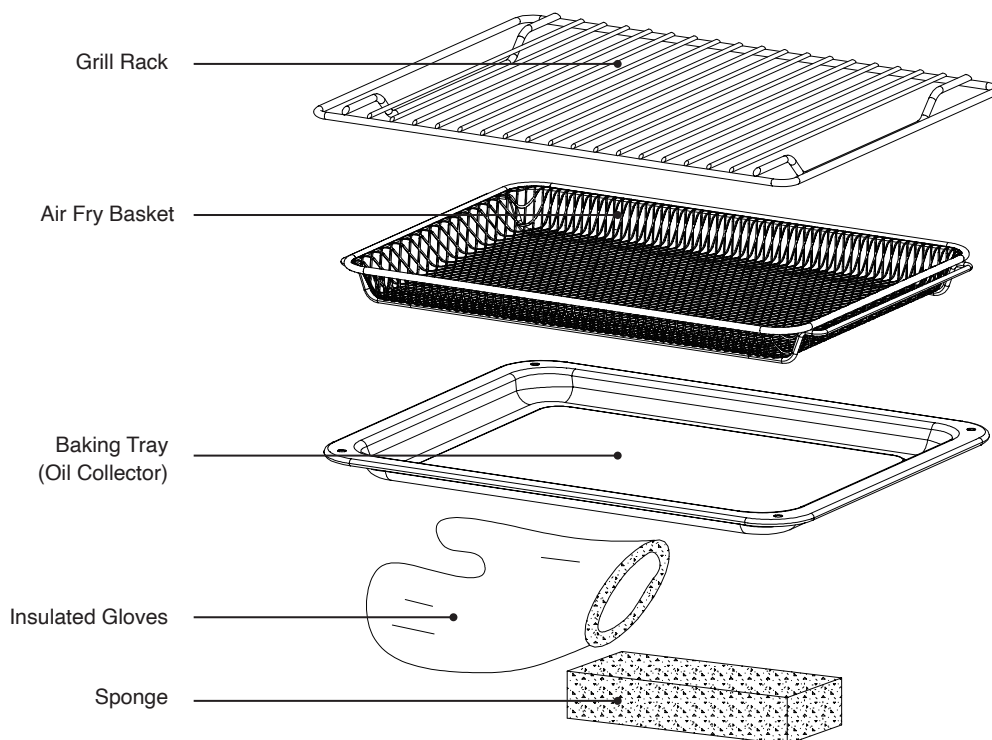

1. Grill Rack

(A) For multi-layers cooking, it is recommended to place the grill rack on the lowest level for better air circulation and even oven temperature.

(B) When grilling food without any container, please place baking paper or aluminum foil onto the grill rack before cooking.

(C) The maximum weight that can be placed on the grill rack is 4kg.

2. Air Fry Basket

Mainly for use under “Air Fry” mode.

3. Baking Tray (oil collector)

(A) When baking food without any container, please place baking paper or aluminum foil onto the metal tray.

(B) The maximum weight that can be placed on the metal tray is 5 kg.

4. Insulated gloves

To take food or rack out from the combi steamer.

5. Sponge

To remove condensation inside the oven.





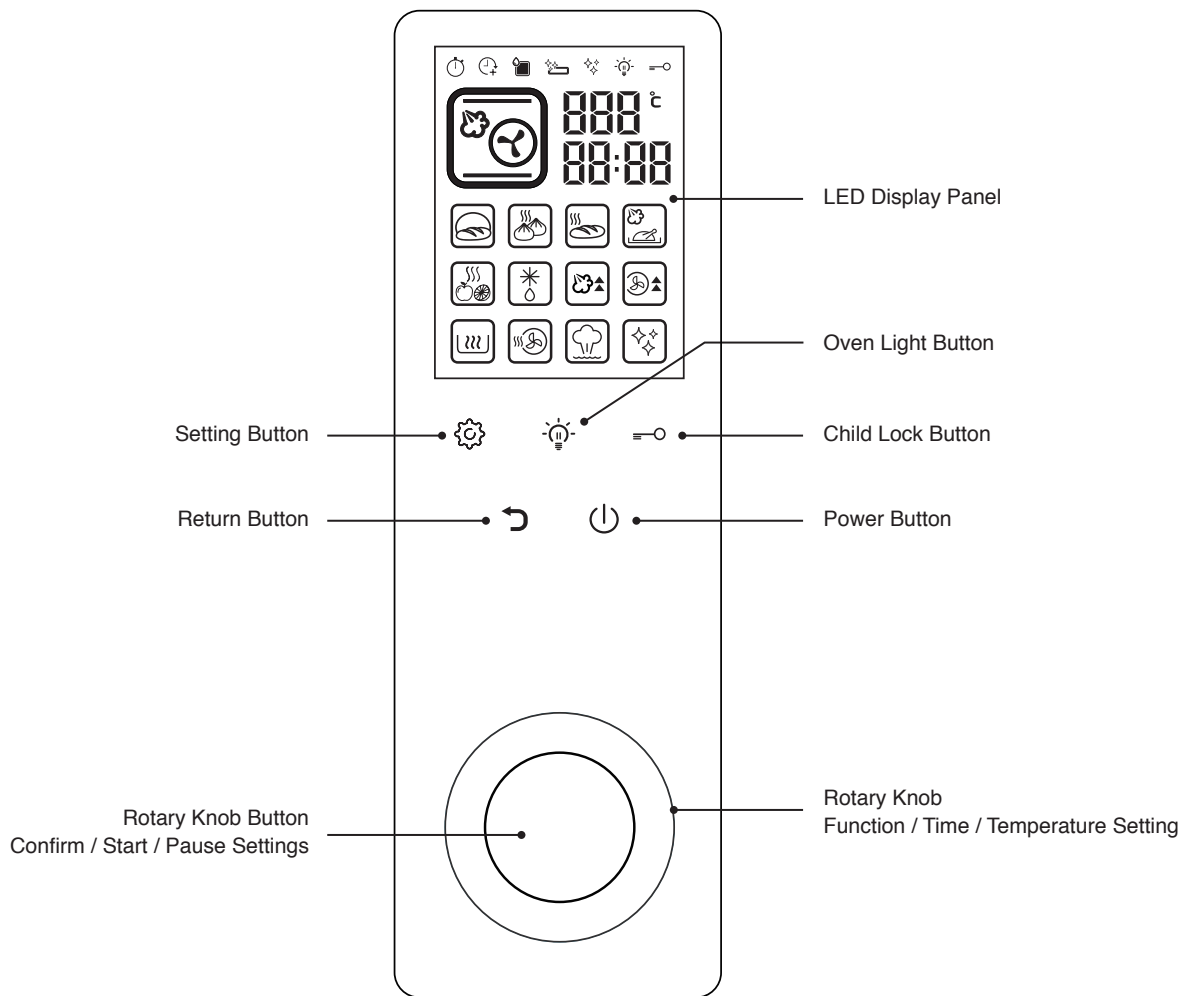
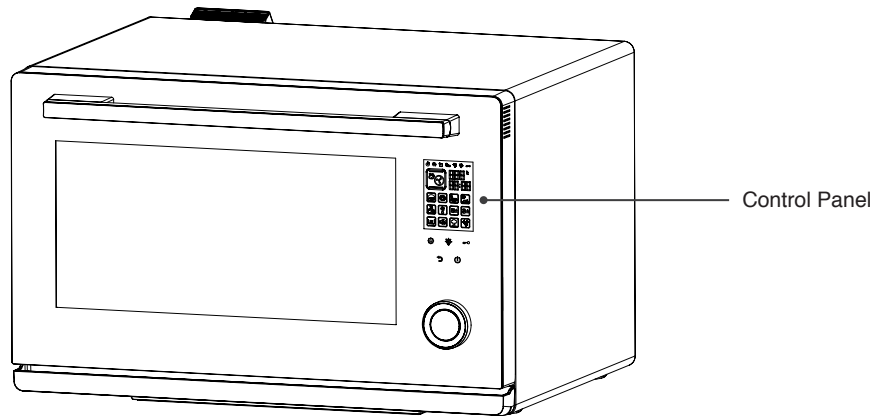

General Preparation and Advice before Use

■ Control Panel

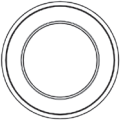

General Preparation and Advice before Use

■ Control Panel – Basic Functions

Icon	Function Descriptions
	<p>Rotary Knob Function / Time / Temperature Settings</p> <p>Rotary Knob Button Confirm / Start / Pause Settings</p>
	<p>Setting Button</p> <ol style="list-style-type: none"> 1. Setting the clock: In standby mode, press and hold the setting button for 3 seconds to enter the clock setting screen to set the clock (See “Setting the Clock” on page 57 for detailed instructions). 2. Preset function: After setting the cooking mode, cooking time and cooking temperature, press the setting button to enter the preset screen to preset the timer (See “Preset Function” on page 78-79 for detailed instructions). 3. In pause mode, press the setting button to reset cooking time and temperature (See “Adjust the setting during cooking process” on page 80 for detailed instructions).
	<p>Return Button</p> <ol style="list-style-type: none"> 1. Return / Reset; 2. Press the return button during setting to go back to the previous screen or reset cooking modes or cooking time.
	<p>Oven Light Button</p> <ol style="list-style-type: none"> 1. Touch once to switch the light on for 3 minutes. The oven light icon will not light up on the display panel. 2. Press and hold for 3 seconds, the oven light will stay on. The oven light icon will light up on the display panel. Press and hold for 3 seconds again to switch off the oven light. 3. The oven light will light up for 3 minutes when the door is open.
	<p>Child Lock Button</p> <p>Press and hold the button for 3 seconds to activate / release the child lock.</p> <p>To activate child lock: Press and hold the button for 3 seconds. The control panel will be locked and no operation is possible. The child lock icon lights up on the display panel.</p> <p>To release child lock: To release, press and hold the child lock button for 3 seconds while it is activated.</p>
	<p>Power Button</p> <p>After 5 minutes without operation after activate the combi steamer, including opening or closing the oven door. Combi steamer will automatically enter to power-saving mode, display panel goes out. In power-saving mode, only power button is operable.</p>

General Preparation and Advice before Use

Control Panel - Major Features

Water Tank Icon

This icon lights up as the function operated with water, please ensure water tank is filled before cooking. Flashing icon indicates that water tank is empty.

Drip Tray Cleaning Reminder

This icon lights up only if the steam mode has been in operation, the icon will flash for 3 minutes.

Adjust the setting during cooking process / Extended Cooking Time

Descaling Reminder

Oven Light

Child Lock

Temperature Setting

Adjustment range: 30°C - 230°C





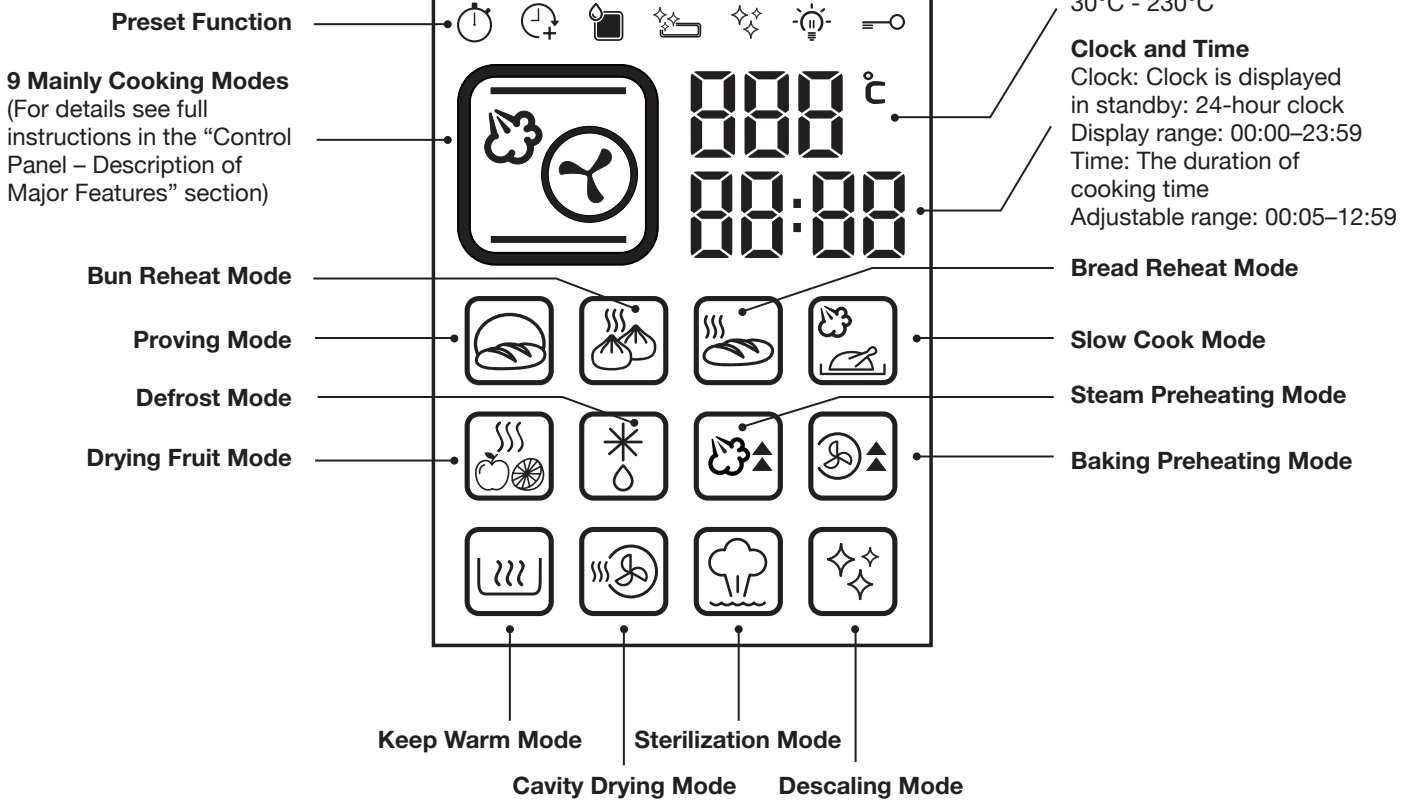

Clock and Time

Clock: Clock is displayed in standby: 24-hour clock
Display range: 00:00-23:59
Time: The duration of cooking time
Adjustable range: 00:05-12:59









General Preparation and Advice before Use









■ Control Panel – Description of Major Features

Icon	Mode	Function Descriptions	Default Time/ Temperature	Time/ Temperature Selection Range
	Steam	Steam cooking preserves the original taste, nutrients and color of food cooked. It is suitable for steaming vegetables, meat and seafood or braising soup.	30 minutes / 100°C	Time: 5-419 mins (maximum 6 hours 59 mins) Temperature: 50-110°C
	Forced Air + Steam	Cooking food with hot air and steam to prevent moisture loss during high baking temperature. The rear fan produces good circulation of hot air to ensure even heating on multiple levels. This mode is suitable for all types of food.	30 minutes / 180°C	Time: 5-90 mins (maximum 1 hours 30 mins) Temperature: 100-230°C
	Upper Grill	Suitable for roasting baking-food or at a final stage of roasting or baking. It helps browning the surface of your dish.	30 minutes / 180°C	Time: 5-90 mins (maximum 1 hours 30 mins) Temperature: 100-230°C
	Bottom Grill	Suitable for baking the final stage or for food that needs to be cooked from the bottom periodically during cooking. e.g. pizzas, macaroon.	30 minutes / 180°C	Time: 5-90 mins (maximum 1 hours 30 mins) Temperature: 100-230°C
	Conventional Bake	Traditional single-level baking and grilling mode. Heat is released from the top and bottom to get food baked evenly. Suitable for cooking meat, fish, bread and cookies, pastries and desserts etc., and particularly suitable for cakes with moist ingredients at the top.	30 minutes / 180°C	Time: 5-90 mins (maximum 1 hours 30 mins) Temperature: 100-230°C
	Forced Air	The appliance comes with a rear fan which distributes the hot air produced by the rear heater evenly inside the oven. Food on different levels are heated evenly. It can be used in cooking multiple levels.	30 minutes / 180°C	Time: 5-90 mins (maximum 1 hours 30 mins) Temperature: 100-230°C

General Preparation and Advice before Use

Icon	Mode	Function Descriptions	Default Time/ Temperature	Time/ Temperature Selection Range
	Convection	The upper and bottom heater and rear fan operate simultaneously in this mode. Suitable for all baking dishes, such as meat, seafood, pizzas, bread and cookies, pastries and desserts.	30 minutes / 180°C	Time: 5-90 mins (maximum 1 hours 30 mins) Temperature: 100-230°C
	Air Fry	This mode uses fan to circulate heat inside the cavity to air fry food. It is suitable for crispy food or baking large meat.	30 minutes / 180°C	Time: 5-90 mins (maximum 1 hours 30 mins) Temperature: 100-230°C
	Convection + Steam	This mode combines upper, lower heat, hot air and steam cooking. It is a perfect all-in-one combination cooking. Adding steam during the cooking process can prevent moisture loss during high temperature cooking. Suitable for cooking all types of food, such as large cuts of meat or baking moist cakes.	30 minutes / 180°C	Time: 5-90 mins (maximum 1 hours 30 mins) Temperature: 100-230°C
	Proving	This mode works with steam to ensure stable and humidity inside the oven. It allows doughs (for pizzas or bread) to rise quicker in a stable environment, and it used for fermenting pizzas or bread.	30 minutes / 35°C	Time: 5-419 mins (maximum 6 hours 59 mins) Temperature: 30-40°C
	Bun Reheat	Bun is reheated at a regulated temperature and steam is added to reheat that tastes just like freshly-steamed bun.	10 minutes / 100°C	Time: 5-59 mins Temperature: Cannot be adjusted
	Bread Reheat	Bread is reheated at a regulated temperature to reheat bread that tastes just like freshly-baked.	10 minutes / 160°C	Time: 5-59 mins Temperature: Cannot be adjusted
	Slow Cook	Steam is injected to maintain temperature inside the oven for slow cooking. Low temperature is used, meat and seafood can be preserved the original flavor without overcooking. Food can be placed in vacuum bags for this mode.	30 minutes / 60°C	Time: 5-419 mins (maximum 6 hours 59 mins) Temperature: 50-90°C

General Preparation and Advice before Use

Icon	Mode	Function Descriptions	Default Time/ Temperature	Time/ Temperature Selection Range
	Drying Fruit	Food is dehydrated with hot air in low heat. Suitable for preparing dried fruit and sliced vegetable or meat jerkies.	60 minutes / 80°C	Time: 5-779 mins (maximum 12 hours 59 mins) Temperature: 40-90°C
	Defrost	Defrost chilled or frozen food.	30 minutes / 55°C	Time: 5-419 mins (maximum 6 hours 59 mins) Temperature: 50-60°C
	Preheat – Steam	Oven is heated to preset temperature by steam.	Present time / 100°C	Temperature: 50-110°C
	Preheat – Baking	Oven is heated to preset temperature by baking function.	Present time / 180°C	Temperature: 100-230°C
	Keep Warm	Keeping food warm with hot air. Suitable for keeping cooked dishes warm.	30 minutes / 55°C	Time: 5-239 mins (maximum 3 hours 59 mins) Temperature: 50-60°C
	Cavity Drying	In this mode, the oven is heated to a high temperature so any excessive moisture and steam are evaporated. This function is used for drying the oven after any steam cooking modes.	25 minutes / 230°C	Time: Cannot be adjusted Temperature: Cannot be adjusted
	Sterilization	At sterilization mode, high temperature 110°C is used to sterilize dinnerware, cutlery or feeding bottles.	30 minutes / 110°C	Time: 5-419 mins (maximum 6 hours 59 mins) Temperature: Cannot be adjusted
	Descaling	Descaling icon will be on once combi steamer has reached 100 hours steam related cooking time to remind the user to run descaling programme mode. A descaler is required.	50 minutes / 85°C	Time: Cannot be adjusted Temperature: Cannot be adjusted

General Preparation and Advice before Use

■ Use and Cooking Tips

1. Minimum time setting is 5 minutes for all cooking modes (Except the “Increase the Cooking Time after Cooking is Completed” function).
2. After specific cooking functions are done, the fan will continue to work for 3 minutes for cool down purpose. This is normal.
3. The combi steamer will pause automatically if you open the oven door during cooking. Cooking will continue automatically at the set time and temperature once the door is closed.
4. Take extra care when removing container from the oven after heating, like soup, sauce or beverage. To prevent over boiling, following steps should be taken in cooking liquid.
 - (a) Do not over-heat liquid food. Boiling liquid may splash out and cause scalding when you remove it from the combi steamer.
 - (b) When heating up liquid food, make sure the container is at most 80% full because a small amount of liquid may splash out suddenly when boiled.
 - (c) Stir the liquid before and during heating.
 - (d) Allow the food to stand inside the combi steamer for a while when heating is done. Stir it gently before removing.
 - (e) When using a feeding bottle or heating baby food, stir or shake the food and check the temperature before feeding to avoid burning.
5. Only use a thermometer designed for ovens to check food temperature during cooking, if necessary. If longer cooking time is required, put the food back into the combi steamer to continue cooking.
6. To avoid overheating or over-browning, it is recommended to take the food out when roasting or steaming is finished.
7. To maintain constant temperature during cooking, do not open the oven door unless it is necessary. To avoid affecting oven temperature, do not open the oven door to check food during cooking. If you have opened the oven door, extend the cooking time accordingly.
8. To ensure even browning and cooking, adjust or turn the food's position or direction of the steam or grill plate halfway during heating.

Operation Instructions

■ Setting the Clock

When the appliance is first powered on, it will beep and returned to standby mode. The default clock display is 12:00. The display panel lights up completely.



The combi steamer returns to energy saving mode if no button is pressed or door is opened for 5 minutes. Under energy saving mode, display will be turned off, only the power button can be used. Press the power button to exit the energy saving mode and back to the startup screen.

Example: Set the clock to the current time 13:20.

Steps:

1. On the standby screen, press and hold the setting button  for 3 seconds. The hour digits flash.
(as shown in the diagram below)



2. Set the hour by turning the knob. When the hour reaches 13, press the knob to confirm.
(as shown in the diagram below) The display will change to the minute setting automatically. The minute digits flash.



3. Set the minute by turning the knob. When the minute reaches 20, press the knob to confirm.
(as shown in the diagram below)



4. Time setting is complete. (as shown in the diagram below)



Important: If no action is taken within 5 minutes during the setting process, all settings will be cancelled and the display will return to the standby screen. The combi steamer is in standby.

Operation Instructions

■ Steam Mode



Steam cooking preserves the original taste, nutrients and color of food. It is suitable for steaming vegetables, meat and seafood or braising soup. Always ensure the water tank is filled before using this mode.

	Temperature	Time
Default Setting	100°C	30 mins
Setting Range	50°C - 110°C	5 mins - 6 hours and 59 mins

Example: Set the cooking time to 1 hour and 40 minutes; cooking temperature is 90°C.

Steps:

1. In standby mode, turn the knob clockwise to  Steam Mode. The icon will flash. Press the knob to confirm (as shown in the diagram below). The display will jump to temperature setting automatically.

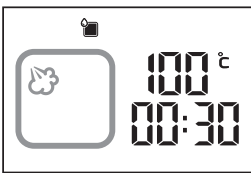

2. Turn the knob until the temperature display shows 90°C. Press the knob to confirm (as shown in the diagram below). The display will jump to hour setting automatically.

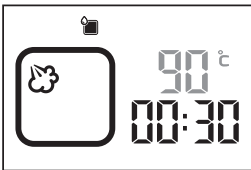

3. Turn the knob until the hour display shows 01. Press the knob to confirm (as shown in the diagram below). The display will jump to minute setting automatically.

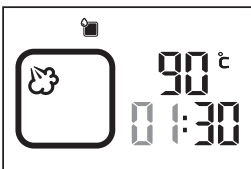

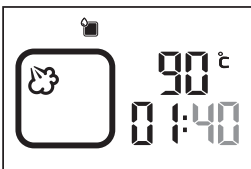

4. Turn the knob until the minutes display shows 40. Press the knob to confirm (as shown in the diagram below).

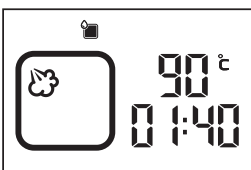

5. Setting is complete. The combi steamer will start cooking (as shown in the diagram below).



When cooking is completed, the “END” will be shown on display and an audio tone sounds. The  “Extended Cooking Time” icon (customer can increase the cooking time after cooking is completed) and  “Drip Tray Cleaning Reminder” icon (customer has to clear up the water in the drip tray if any) will flash.

Operation Instructions

■ Forced Air + Steam Mode



Cooking food with hot air and steam to prevent moisture loss during high temperature cooking. The rear fan provides good circulation of hot air to ensure even heating on multiple levels. This mode is suitable for all types of food. It is recommended to place aluminum foil or baking paper onto the baking tray cooking. Always ensure the water tank is filled before using this mode.

	Temperature	Time
Default Setting	180°C	30 mins
Setting Range	100°C - 230°C	5 mins - 1 hours and 30 mins

Example: Set the cooking time to 40 minutes; cooking temperature is 210°C.

Steps:

1. In standby mode, turn the knob clockwise to  Forced Air + Steam Mode. The icon will flash. Press the knob to confirm (as shown in the diagram below). The display will jump to temperature setting automatically.

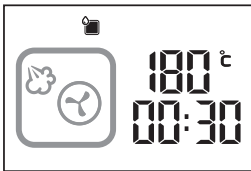

2. Turn the knob until the temperature display shows 210°C. Press the knob to confirm (as shown in the diagram below). The display will jump to hour setting automatically.

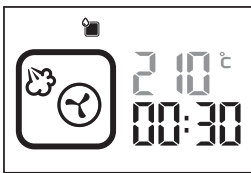

3. Press the knob to confirm 00 hour setting (as shown in the diagram below). The display will jump to minute setting automatically.

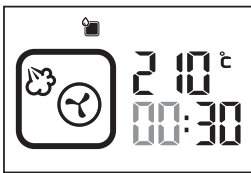

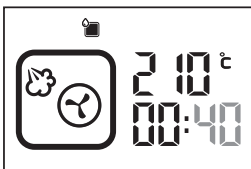

4. Turn the knob until the minute display shows 40. Press the knob to confirm (as shown in the diagram below).

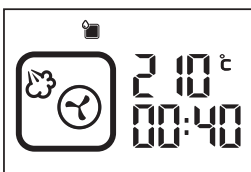

5. Setting is complete. The combi steamer will start cooking. (as shown in the diagram below)



When cooking is completed, the “END” will be shown on display and an audio tone sounds. The  “Extended Cooking Time” icon (customer can increase the cooking time after cooking is completed) and  “Drip Tray Cleaning Reminder” icon (customer has to clear up the water in the drip tray if any) will flash.

Operation Instructions

■ Upper/ Bottom Grill/ Conventional Bake Mode

Three grill modes are available: upper grill, bottom grill and conventional bake (upper and bottom grill). You can select a suitable mode according to the types of food and cooking result that you are looking for. It is recommended to place aluminum foil or baking paper onto the baking tray before cooking.

Upper Grill Mode: Suitable for roasting baking food or at a final stage of roasting or baking. It helps browning the surface of your dish.

Bottom Grill Mode: Suitable for baking in the final stage or for food that needs to be cooked from the bottom periodically during cooking, e.g. pizzas, macaroon.

Conventional Mode: Traditional single-level baking and grilling mode. Heat is released from the top and bottom to get food baked evenly. Suitable for cooking meat, fish, bread and cookies, pastries and desserts etc., and particularly suitable for cakes with moist ingredients at the top.

	Temperature	Time
Default Setting	180°C	30 mins
Setting Range	100°C - 230°C	5 mins - 1 hours and 30 mins

Example: Set the cooking time to 40 minutes; cooking temperature is 210°C.

Steps:

- In standby mode, turn the knob clockwise to  or  or  Mode. Icon of the selected grill mode will flash. Press the knob to confirm (as shown in the diagram below). The display will jump to temperature setting automatically.



- Turn the knob until temperature display shows 210°C. Press the knob to confirm (as shown in the diagram below). The display will jump to hour setting automatically.



- Press the knob to confirm the 00 hour setting (as shown in the diagram below). The display will jump to minute setting automatically.



- Turn the knob until the minute display shows 40. Press the knob to confirm (as shown in the diagram below).



- Setting is complete. The combi steamer will start cooking. (as shown in the diagram below)



When cooking is completed, the "END" will be shown on display and an audio tone sounds. The  "Extended Cooking Time" icon (customer can increase the cooking time after cooking is completed) will flash.

Operation Instructions

■ Forced Air Mode



The appliance comes with a rear fan which distributes the hot air produced by the rear heater evenly inside the oven. Foods on different levels are heated evenly. It can be used in cooking multiple levels. It is recommended to place aluminum foil or baking paper onto the baking tray before cooking.

	Temperature	Time
Default Setting	180°C	30 mins
Setting Range	100°C - 230°C	5 mins - 1 hours and 30 mins

Example: Set the cooking time to 40 minutes; cooking temperature is 210°C.

Steps:

1. In standby mode, turn the knob clockwise to  Forced Air Mode. The icon will flash. Press the knob to confirm (as shown in the diagram below). The display will jump to temperature setting automatically.



2. Turn the knob until the temperature display shows 210°C. Press the knob to confirm (as shown in the diagram below). The display will jump to hour setting automatically.



3. Press the knob to confirm 00 hour setting (as shown in the diagram below). The display will jump to minute setting automatically.



4. Turn the knob until the minute display shows 40. Press the knob to confirm (as shown in the diagram below).



5. Setting is complete. The combi steamer will start cooking. (as shown in the diagram below)



When cooking is completed, the “END” will be shown on display and an audio tone sounds. The  “Extended Cooking Time” icon (customer can increase the cooking time after cooking is completed) will flash.

Operation Instructions

■ Convection Mode



The upper and lower heaters and rear fan operate simultaneously in this mode. Suitable for all baking dishes, such as meat, seafood, pizzas, bread and cookies, pastries and desserts. It is recommended to place aluminum foil or baking paper onto the baking tray before cooking.

	Temperature	Time
Default Setting	180°C	30 mins
Setting Range	100°C - 230°C	5 mins - 1 hours and 30 mins

Example: Set the cooking time to 40 minutes; cooking temperature is 210°C.

Steps:

1. In standby mode, turn the knob clockwise to  Convection Mode. The icon will flash. Press the knob to confirm (as shown in the diagram below). The display will jump to temperature setting automatically.

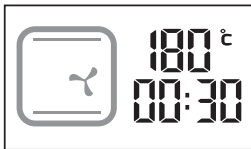

2. Turn the knob until the temperature display shows 210°C. Press the knob to confirm (as shown in the diagram below). The display will jump to hour setting automatically.



3. Press the knob to confirm the 00 hour setting (as shown in the diagram below). The display will jump to minute setting automatically.



4. Turn the knob until the minute display shows 40. Press the knob to confirm (as shown in the diagram below).



5. Setting is complete. The combi steamer will start cooking. (as shown in the diagram below)



When cooking is completed, the “END” will be shown on display and an audio tone sounds. The  “Extended Cooking Time” icon (customer can increase the cooking time after cooking is completed) will flash.

Operation Instructions

■ Air Fry Mode

This mode uses fan to circulate heat inside the cavity to air fry food. It is suitable for crispy food or baking large meat.

	Temperature	Time
Default Setting	180°C	30 mins
Setting Range	100°C - 230°C	5 mins - 1 hours and 30 mins

Example: Set the cooking time to 40 minutes; cooking temperature is 210°C.

Steps:

1. In standby mode, turn the knob clockwise to  Air Fry Mode. The icon will flash. Press the knob to confirm (as shown in the diagram below). The display will jump to temperature setting automatically.

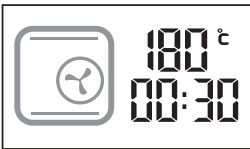

2. Turn the knob until the temperature display shows 210°C. Press the knob to confirm (as shown in the diagram below). The display will jump to hour setting automatically.



3. Press the knob to confirm the 00 hour setting (as shown in the diagram below). The display will jump to minute setting automatically.



4. Turn the knob until the minute display shows 40. Press the knob to confirm (as shown in the diagram below).



5. Setting is complete. The combi steamer will start cooking (as shown in the diagram below).



When cooking is completed, the “END” will be shown on display and an audio tone sounds. The  “Extended Cooking Time” icon (customer can increase the cooking time after cooking is completed) will flash.

Operation Instructions

■ Convection + Steam Mode



This mode combines upper, lower heat, hot air and steam cooking. It is a perfect all-in-one combination cooking. Adding steam during the cooking process can prevent moisture loss during high temperature cooking. Suitable for cooking all types of food, such as large cuts of meat or baking moist cakes. It is recommended to place aluminum foil or baking paper onto the baking tray before cooking. Always ensure that the water tank is filled before using this mode.

	Temperature	Time
Default Setting	180°C	30 mins
Setting Range	100°C - 230°C	5 mins - 1 hours and 30 mins

Example: Set the cooking time to 40 minutes; cooking temperature is 210°C.

Steps:

1. In standby mode, turn the knob clockwise to  Convection + Steam Mode. The icon will flash. Press the knob to confirm (as shown in the diagram below). The display will jump to temperature setting automatically.

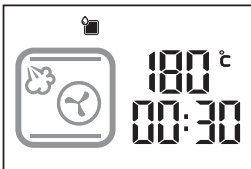

2. Turn the knob until the temperature display shows 210°C. Press the knob to confirm (as shown in the diagram below). The display will jump to hour setting automatically.

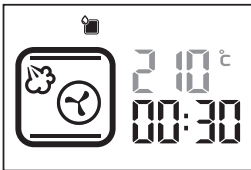

3. Press the knob to confirm 00 hour setting (as shown in the diagram below). The display will jump to minute setting automatically.

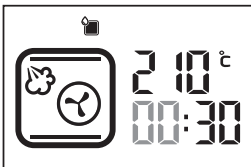

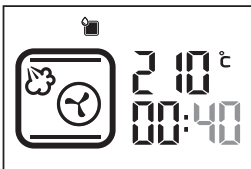

4. Turn the knob until the minute display shows 40. Press the knob to confirm (as shown in the diagram below).

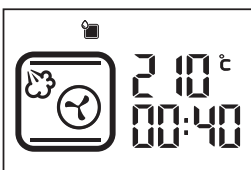

5. Setting is complete. The combi steamer will start cooking. (as shown in the diagram below)



When cooking is completed, the “END” will be shown on display and an audio tone sounds. The  “Extended Cooking Time” icon (customer can increase the cooking time after cooking is completed) and  “Drip Tray Cleaning Reminder” icon (customer has to clear up the water in the drip tray if any) will flash.

Operation Instructions

■ Proving Mode



This mode works with steam to ensure stable high temperature and humidity inside the oven. It allows dough (for pizza or bread) to rise quicker in a stable environment, and is used for fermenting dough for pizzas or bread. Always ensure that the water tank is filled before using this mode.

	Temperature	Time
Default Setting	35°C	30 mins
Setting Range	30°C - 40°C	5 mins - 6 hours and 59 mins

Example: Set the cooking time to 40 minutes; cooking temperature is 35°C.

Steps:

1. In standby mode, turn the knob clockwise to  Proving Mode. The icon will flash. Press the knob to confirm (as shown in the diagram below). The display will jump to temperature setting automatically.

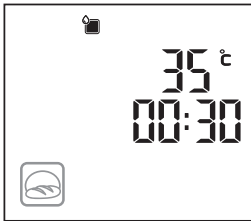

2. Press the knob to confirm the 35°C temperature setting (as shown in the diagram below). The display will jump to hour setting automatically.

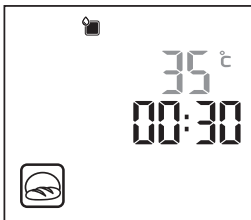

3. Press the knob to confirm 00 hour setting (as shown in the diagram below). The display will jump to minute setting automatically.



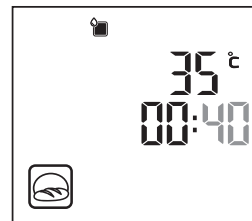

4. Turn the knob until the minute display shows 40. Press the knob to confirm (as shown in the diagram below).



5. Setting is complete. The combi steamer will start cooking (as shown in the diagram below).



When cooking is completed, the “END” will be shown on display and an audio tone sounds. The  “Extended Cooking Time” icon (customer can increase the cooking time after cooking is completed) and  “Drip Tray Cleaning Reminder” icon (customer has to clear up the water in the drip tray if any) will flash.

Operation Instructions

■ Bun Reheat Mode



Bun reheated at a regulated temperature and steam is added to reheat that tastes just like freshly-steamed bun. Always ensure that the water tank is filled before using this mode.

Suggested cooking time: Reheating time for frozen bun: about 10-15 minutes; Reheating time for room temperate bun: about 8-13 minutes. It is recommended to add cooking time for bun with fillings as needed. This suggested cooking time is solely for reference. Cooking time is affected by bread's quantity, size, type and personal taste.

	Temperature	Time
Default Setting	100°C	10 mins
Setting Range	Cannot be adjusted	5 - 59mins

Example: Cooking bread that has been refrigerated. Set the cooking time to 25 minutes.

Steps:

1. In Standby mode, turn the knob clockwise to  Bun Reheat Mode, the icon will flash. Press the knob to confirm (as shown in the diagram below). The display will jump to minute setting automatically.

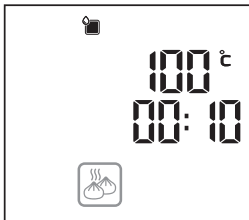

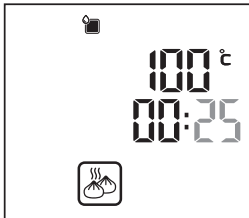

2. Turn the knob until the minute display shown 25. Press the knob to confirm (as shown in the diagram below).

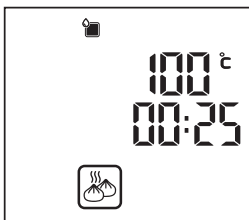

3. Setting is complete. The combi steamer will start cooking. (as shown in the diagram below)



When cooking is completed, the "END" will be shown on display and an audio tone sounds. The  "Extended Cooking Time" icon (customer can increase the cooking time after cooking is completed) and  "Drip Tray Cleaning Reminder" icon (customer has to clear up the water in the drip tray if any) will flash.

Operation Instructions

■ Bread Reheat Mode

Bread is reheated at a regulated temperature that tastes just like freshly-baked.

Suggested cooking time: Reheating time for frozen bread: about 10-15 minutes; Reheating time for room temperature bread: about 8-13 minutes. It is recommended to add cooking time for bread with fillings as needed. This suggested cooking time is solely for reference. Cooking time is affected by the bread's quantity, size, type and personal taste.

	Temperature	Time
Default Setting	160°C	10 mins
Setting Range	Cannot be adjusted	5 mins - 59 mins

Example: Cooking bread that has been refrigerated. Set the cooking time to 25 minutes

Steps:

1. In standby mode, turn the knob clockwise to  Bread Reheat Mode. The icon will flash. Press the knob to confirm (as shown in the diagram below). The display will jump to minute setting automatically.

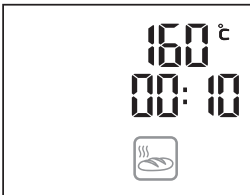

2. Turn the knob until the minute display shows 25. Press the knob to confirm (as shown in the diagram below).

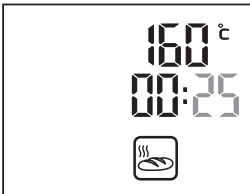

3. Setting is complete. The combi steamer will start cooking (as shown in the diagram below).



When cooking is completed, the "END" will be shown on display and an audio tone sounds. The  "Extended Cooking Time" icon (customer can increase the cooking time after cooking is completed) will flash.

Operation Instructions

■ Slow Cook Mode

Steam is injected to maintain temperature inside the oven for slow cooking. Low temperature is used, meat and seafood can be preserved the original flavor without overcooking. Food can be placed in vacuum bags. Always ensure that the water tank is filled before using this mode.

	Temperature	Time
Default Setting	60°C	30 mins
Setting Range	50°C - 90°C	5 mins - 6 hours and 59 mins

Example: Set the cooking time to 40 minutes; cooking temperature is 60°C.

Steps:

1. In standby mode, turn the knob clockwise to  Slow Cook Mode. The icon will flash. Press the knob to confirm (as shown in the diagram below). The display will jump to temperature setting automatically.

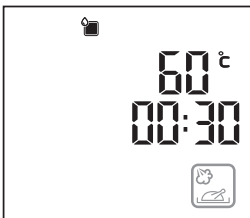

2. Press the knob to confirm the 60°C temperature setting (as shown in the diagram below). The display will jump to hour setting automatically.

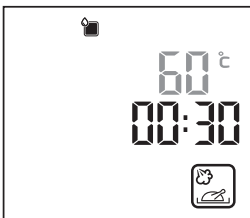

3. Press the knob to confirm 00 hour setting (as shown in the diagram below). The display will jump to minute setting automatically.

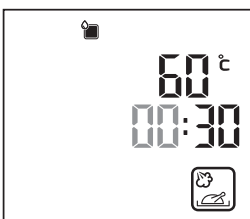



4. Turn the knob until the minute display shows 40. Press the knob to confirm (as shown in the diagram below).



5. Setting is complete. The combi steamer will start cooking (as shown in the diagram below).



When cooking is completed, the "END" will be shown on display and an audio tone sounds.

The  "Extended Cooking Time" icon (customer can increase the cooking time after cooking is completed) and  "Drip Tray Cleaning Reminder" icon (customer has to clear up the water in the drip tray if any) will flash.

Operation Instructions

■ Drying Fruit Mode

Food is dehydrated with hot air in low heat. Suitable for preparing dried fruit and vegetable slices or meat jerkies.

	Temperature	Time
Default Setting	80°C	60 mins
Setting Range	40°C - 90°C	5 mins - 12 hours and 59 mins

Example: Set the cooking time to 2 hours; cooking temperature is 90°C.

Steps:

1. In standby mode, turn the knob clockwise to  Drying Fruit Mode. The icon will flash. Press the knob to confirm (as shown in the diagram below). The display will jump to temperature setting automatically.

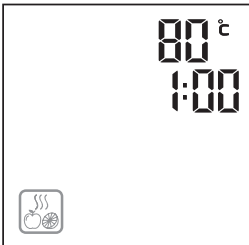

2. Turn the knob until the temperature display shows 90°C. Press the knob to confirm (as shown in the diagram below). The display will jump to hour setting automatically.

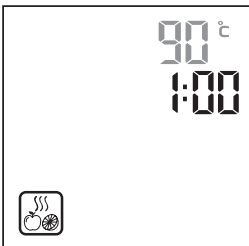

3. Turn the knob until the hour display shows 02. Press the knob to confirm (as shown in the diagram below). The display will jump to minute setting automatically.

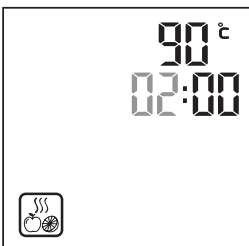

4. Press the knob to confirm the 00 minute setting (as shown in the diagram below).

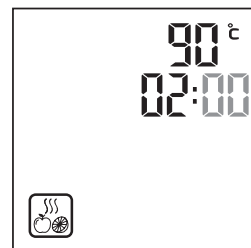

5. Setting is complete. The combi steamer will start cooking (as shown in the diagram below).

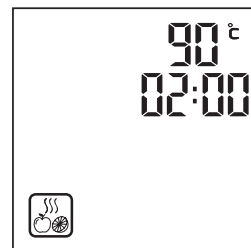

When cooking is completed, the “END” will be shown on display and an audio tone sounds. The  “Extended Cooking Time” icon (customer can increase the cooking time after cooking is completed) will flash.

Operation Instructions

■ Defrost Mode



Defrost chilled or frozen food with steam. Always ensure that the water tank is filled before using this mode.

	Temperature	Time
Default Setting	55°C	30 mins
Setting Range	50°C - 60°C	5 mins - 6 hours and 59 mins

Example: Set the cooking time to 1 hour and 40 minutes; defrosting temperature is 60°C.

Steps:

- In standby mode, turn the knob clockwise to  Defrost Mode. The icon will flash. Press the knob to confirm (as shown in the diagram below). This display will jump to temperature setting automatically.



- Turn the knob until the temperature display shows 60°C. Press the knob to confirm (as shown in the diagram below). The display will jump to hour setting automatically.

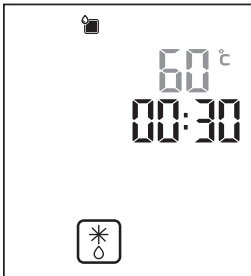

- Turn the knob until the hour display shows 01. Press the knob to confirm (as shown in the diagram below). The display will jump to minute setting automatically.





- Turn the knob until the minute display shows 40. Press the knob to confirm (as shown in the diagram below).



- Setting is complete. The combi steamer will start cooking (as shown in the diagram below).



When cooking is completed, the “END” will be shown on display and an audio tone sounds.

The  “Extended Cooking Time” icon (customer can increase the cooking time after cooking is completed) and  “Drip Tray Cleaning Reminder” icon (customer has to clear up the water in the drip tray if any) will flash.

Operation Instructions

■ Preheat - Steam Mode

The Preheat Mode can be operated with steam mode. The oven will be heated to preset temperature.

Temperature	
Default Setting	100°C
Setting Range	50°C - 110°C

Oven will automatically adjust the cooking time according to set temperature. “END” will be displayed and an audio tone will be heard when the temperature reaches the preset temperature. Current time is displayed during preheating. Always ensure that the water tanks is filled before using steam preheating.

Example: Set the steam preheating temperature to 100°C.

Steps:

1. In standby mode, turn the knob clockwise to  Steam Preheating Mode. The icon will flash. Steam is the default setting. Press the knob to confirm (as shown in the diagram below).



2. The display will jump to temperature setting automatically. Press the knob to confirm the default temperature 100°C (as shown in the diagram below).



3. Setting is complete. The combi steamer will start preheating (as shown in diagram below).



When preheating is complete, the display will show “END” and an audio tone will be heard. The  “Drip Tray Cleaning Reminder” icon (customer has to clear up the water in the drip tray if any) will flash (as shown in the diagram below). After preheating the combi steamer, you can select other cooking modes to continue your cooking as required.

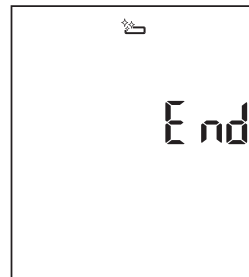

Important: The function of “Increase the Cooking Time after Cooking is Completed” is not available in this mode.

Operation Instructions

■ Preheat - Baking Mode

The Preheat Mode can be operated with baking mode. The oven will be heated to preset temperature.

Temperature	
Default Setting	180°C
Setting Range	110°C - 230°C

Oven will automatically adjust the cooking time according to set temperature. "END" will be displayed and an audio tone will be heard when the temperature reaches the preset temperature. Current time is displayed during preheating.

Example: Set the baking preheating temperature to 200°C.

Steps:

1. In standby mode, turn the knob clockwise to  Baking Preheating Mode. The icon will flash. Press the knob to confirm (as shown in the diagram below).

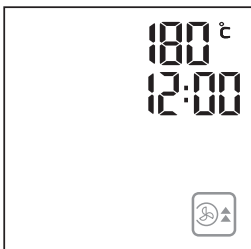

2. The display will jump to temperature setting automatically. Turn the knob until the display shows 200°C. Press the knob to confirm (as shown in the diagram below).

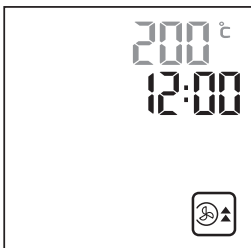

3. Setting is complete. The combi steamer will start preheating (as shown in diagram below).

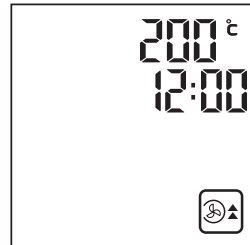

When preheating is complete, the display will show "END" and an audio tone will be heard (as shown in the diagram below). After preheating the combi steamer, you can select other cooking modes to continue your cooking as required.

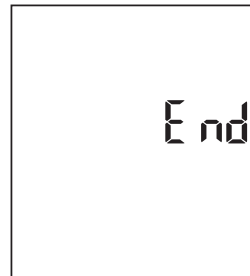

Important: The function of "Increase the Cooking Time after Cooking is Completed" is not available in this mode.

Operation Instructions

■ Keep Warm Mode

Keeping food warm with hot air. Suitable for keeping cooked dishes warm.

	Temperature	Time
Default Setting	55°C	30 mins
Setting Range	50°C - 60°C	5 mins - 3 hours and 59 mins

Example: Set the cooking time to 1 hours and 30 minutes; cooking temperature is 60°C.

Steps:

- In standby mode, turn the knob clockwise to  Keep Warm Mode. The icon will flash. Press the knob to confirm (as shown in the diagram below). The display will jump to temperature setting automatically.



- Turn the knob until the temperature display shows 60°C. Press the knob to confirm (as shown in the diagram below) The display will jump to hour setting automatically.

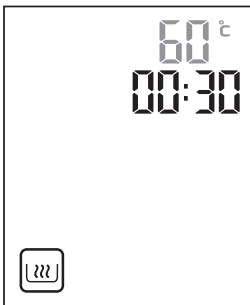

- Turn the knob until the hour display shows 01. Press the knob to confirm (as shown in the diagram below). The display will jump to minute setting automatically.

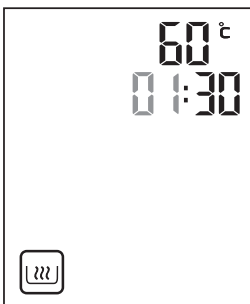

- Press the knob to confirm “30” minute setting (as shown in the diagram below).

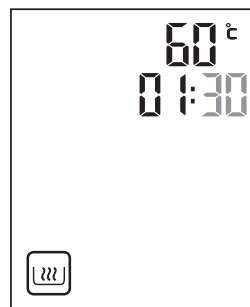

- Setting is complete. The combi steamer will start cooking (as shown in the diagram below).

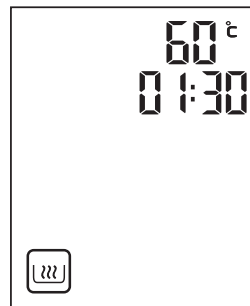

When cooking is completed, the “END” will be shown on display and an audio tone sounds.

The  “Extended Cooking Time” icon (customer can increase the cooking time after cooking is completed) will flash.

Operation Instructions

■ Cavity Drying Mode

In this mode, the oven is heated to a high temperature so any excessive moisture and steam are evaporated. This function is used for drying the oven after any steam cooking modes.

	Temperature	Time
Default Setting	230°C	25 mins
Setting Range	Cannot be adjusted	Cannot be adjusted

Steps:

1. In standby mode, turn the knob clockwise to  Cavity Drying Mode. The icon will flash. Press the knob to confirm (as shown in the diagram below).



2. The combi steamer will start cooking (as shown in the diagram below).

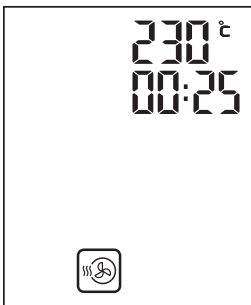

When cooking is completed, the "END" will be shown on display and an audio tone sounds.

The  "Extended Cooking Time" icon (customer can increase the cooking time after cooking is completed) will flash.

Important:

The function of "Adjust the Setting during Cooking Process" is not available in this mode.

Operation Instructions

■ Sterilization Mode

At sterilizing mode, high temperature 110°C is used to sterilize dinnerware, cutlery or feeding bottles. Always ensure that the water tank is filled before using this mode.

	Temperature	Time
Default Setting	110°C	30 mins
Setting Range	Cannot be adjusted	5 mins - 6 hours and 59 mins

Example: Set the cooking time to 35 minutes.

Steps:

- In standby mode, turn the knob clockwise to  Sterilization Mode. The icon will flash. Press the knob to confirm (as shown in the diagram below). The display will jump to hour setting automatically.

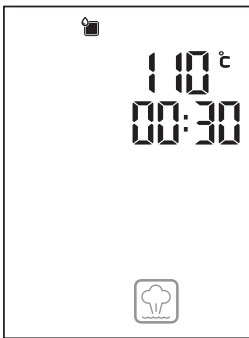

- Turn the knob to confirm the 00 hour setting (as shown in the diagram below). The display will jump to minute setting automatically.





- Turn the knob until the minute display shows 35. Press the knob to confirm (as shown in the diagram below).

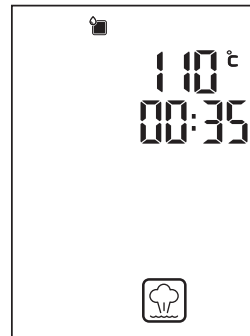

- Setting is complete. The combi steamer will start cooking (as shown in the diagram below).



When cooking is completed, the “END” will be shown on display and an audio tone sounds.

The  “Extended Cooking Time” icon (customer can increase the cooking time after cooking is completed) and  “Drip Tray Cleaning Reminder” icon (customer has to clear up the water in the drip tray if any) will flash.

Operation Instructions

■ Descaling Mode



Water used in steaming mode may result in scale accumulated inside cavity and water pipe.

“Descaling” icon  will be on once combi steamer has reached 100hrs steam related cooking time to remind the user to run the descaling programme mode. The light will stay on until the descaling is performed.

Descaling is carried out in three stages that involve one descaling process and two descaling and cleaning processes. The user has to change the liquid in the tank 3 times during the entire cleaning process. It is also necessary to empty the drip tray by cleaning up. Icon  will be lighted to remind cleaning up the drip tray is needed.

Also, descaler is required for this mode. Customer can select the Wpro descaler under Whirlpool brand. This product can be used in steamer for cleaning limescale deposits effectively, optimizing machine performance and prolonging the lifespan of the appliance. For more details, please visit our website: www.whirlpool.com.hk

For satisfactory results, follow the suggested dosage for descaler and water below:

Stage 1: Descaling. Running time is 30 minutes. Suggested dosage: 10ml descaling agent and 120ml pure water.



Stage 2: 1st descaling and cleaning process. Running time is 10 minutes. Suggested dosage: 130ml pure water.

Stage 3: 2nd descaling and cleaning process. Running time is 10 minutes. Suggested dosage: 130ml pure water.

	Temperature	Time
Default Setting	85°C	50 mins
Setting Range	Cannot be adjusted	Cannot be adjusted

Steps:

1. Stage 1: Descaling

- Fill the water tank up to the level of the descaling 130ml icon  with 10ml descaling agent and 120ml pure water.
- In standby mode, turn the knob clockwise to  Descaling Mode. The icon will flash. Press the knob to confirm (as shown in the diagram below).

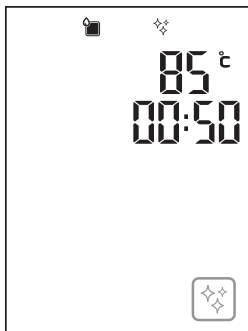



- The descaling mode will start (as shown in the diagram below).





- Stage 1 takes 30 minutes. When done, the time display digits will flash and an audio tone will sound to indicate stage 1 is complete.  Drip tray cleaning reminder icon will flash on the display panel to remind the user to empty the drip tray.
- Pour out the dirty liquid and put the drip tray back into place.

2. Stage 2: 1st descaling and cleaning process

- Open the oven door, fill the water tank up to the level of the descaling 130ml icon  with 130ml pure water.
- Put the water tank back into place and close the oven door. Descaling and cleaning will begin automatically.
- When done, the time display digits will flash and an audio tone will sound to indicate stage 2 is complete.  Drip tray cleaning reminder icon will flash on the display panel to remind the user to empty the drip tray.
- Pour out the dirty liquid and put the drip tray back into place.

Operation Instructions

3. Stage 3: 2nd descaling and cleaning process

- A. Open the oven door. Fill the water tank up to the level of the descaling 130ml icon  with 130ml pure water.
- B. Put the water tank back into place and close the oven door. Descaling and cleaning will begin automatically.
- C. When done, the display will show “END” and an audio tone will sound.  Drip tray cleaning reminder icon will flash on the display panel to remind the user to empty the drip tray.
- D. Pour out the dirty liquid and put the drip tray back into place.

4. Descaling is complete.

Important:

1. The function of “Adjust the setting during Cooking Process / Increase the Cooking Time after Cooking is Completed” is not available in this mode.
2. Descaling mode will be interrupted if the steps of descaling mode is taken in the wrong way (including pause during the descaling process or open and close the oven door not following instructions etc). Please restart descaling mode and follow the instructions in the manual.

Operation Instructions

■ Preset Function

You must set the clock before using the preset function. For instructions on clock setting, please see “Setting the Clock” on page 57 of this instruction manual.

Example: The current time is 16:30. You want to preset cooking time for the Bottom Grill Mode. Cooking time is 40 minutes and temperature is 210°C. Cooking will stop at 18:00.

Steps:

1. In standby mode, turn the knob clockwise  Bottom Grill Mode. The icon will flash. Press the knob to confirm (as shown in the diagram below). The display will jump to temperature setting automatically.

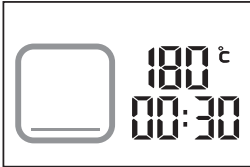

2. Turn the knob until the temperature display shows 210°C. Press the knob to confirm (as shown in the diagram below). The display will jump to hour setting automatically.

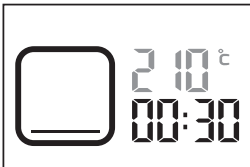

3. Press the knob to confirm the 00 hour setting (as shown in the diagram below). The display will jump to minute setting automatically.

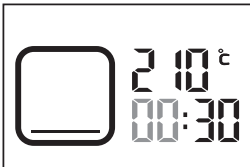

4. Turn the knob until the minute display shows 40. Press the setting button  to confirm (as shown in the diagram below).



5. The screen for presetting the finishing time will be seen. The clock will go back to current time display, i.e. 16:30. The “16” digits will flash. The  preset function icon at the top of the display panel will also flash to indicate preset setting is in process (as shown in the diagram below).



Operation Instructions

6. Turn the knob until the hour display shows 18. Press the knob to confirm (as shown in the diagram below). The display will jump to minute setting automatically .

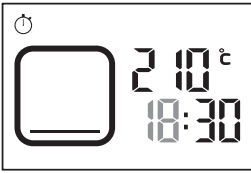



7. Turn the knob until the minute display shows 00. Press the knob to confirm.

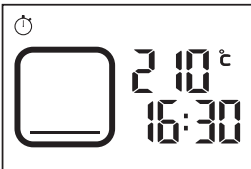

8. The  preset function icon of the display panel will light up. Display will change from operating time back to the current time 16:30, indicating preset setting is complete (as shown in the diagram below).



A. Checking Preset Function Status

Press and hold the setting button  for 3 seconds to check the preset stop time. The preset function icon will flash. Press and hold the setting button  for 3 seconds again to return to the preset function screen.

B. Cancelling Preset Function:

To cancel any preset function setting, press the  power button directly. The combi steamer will return to the standby screen automatically.

Important: Preset Function is available in 9 Mainly Cooking Modes, Bun Reheat Mode, Bread Reheat Mode, Slow Cook Mode and Drying Fruit Mode. (See “Control Panel – Major Features/ Description of Major Features on P.52-55 for details)

Suggestion: Preset cooking operation may be cancelled if children touch the screen accidentally. To avoid this, activate the child lock function after setting the preset function. For instructions on setting the child lock, please see “Control Panel – Basic Functions” on page 51 of this instruction manual. The child lock will not affect cooking. The combi steamer will start cooking normally at the preset time.

Operation Instructions

■ Adjust the Setting during Cooking Process / Increase the Cooking Time after Cooking is Completed.

A. Adjust the setting during cooking process



You can extend or shorten the cooking time and the temperature as required during the cooking process.

Example: Change the cooking time and temperature settings from 01:40 and 90°C to 02:00 and 100°C.

Steps:

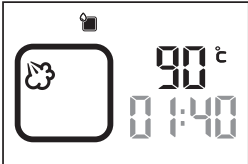
1. During cooking, press the knob to interrupt and pause the cooking. The time display will flash (as shown in the diagram below).



2. Press the setting button . The display will go to the reset cooking time screen automatically. The temperature display flashes, and the  “Adjust the setting during cooking / Extended cooking time” icon lights up on the display (as shown in the diagram below).

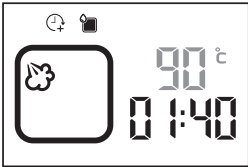

3. Turn the knob until the temperature display shows 100°C. Press the setting button  to confirm (as shown in the diagram below). The display will jump to hour setting automatically.

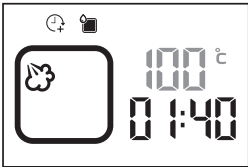

4. Turn the knob until the hour display shows 02. Press the setting button  to confirm (as shown in the diagram below). The display will jump to minute setting automatically.

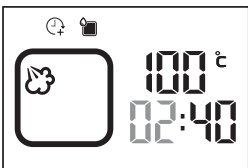

5. Turn the knob until the minute display shows 00. Press the knob to confirm (as shown in the diagram below).

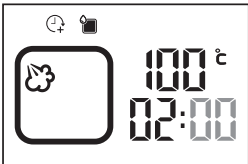

6. Setting is complete. Cooking will be resumed with new settings (as shown in the diagram below).

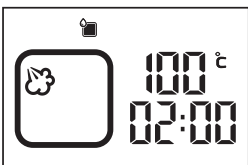



Operation Instructions

B. Increase the cooking time after cooking is completed

You can increase the cooking time after cooking is completed. Temperature cannot be adjusted.

	Temperature	Time
Setting Range	Cannot be adjusted	1 – 59 mins

When cooking is completed, the “END” will be shown on display and an audio tone sounds. The  “Extended Cooking Time” icon will flash on the display and the  “Drip Tray Cleaning Remind” icon will flash for 3 minutes. (Note: the drip tray cleaning reminder icon will light up only if the steam mode has been in operation) (As shown in the diagram below).



To increase the cooking time, follow the steps below:

Example: Cooking is completed and need to increase the cooking time by 3 minutes.

Steps:

1. Press the knob to confirm to increase the cooking time, the display will jump to minute setting automatically.

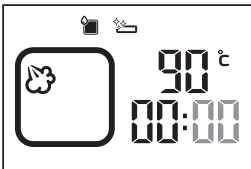

2. Turn the knob until the minute display shows 03. Press the knob to confirm (as shown in the diagram below).

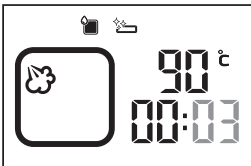

3. Setting is complete. Cooking will resume with added cooking time under previous settings (as shown in the diagram below).

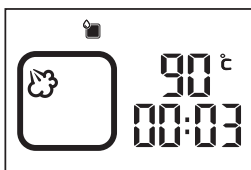

Note: If no action is taken within 5 minutes after cooking is completed, the combi steamer will return to standby mode.

Operation Instructions

■ Residual Heat Indicator

In standby or energy-saving mode the  “Residual Heat Indicator” icon will be shown to warn that cavity exceed 50°C and is not suitable for cleaning (as shown in the diagram below). The icon will be off until cavity drops below 50°C. Users should not clean the appliance until the icon is off.



■ Child Lock

Steamer is equipped with child lock so that children cannot switch on or change any setting accidentally.

A. Activating the Child Lock:

Press and hold the  “Child Lock” button for 3 seconds. Child lock is enabled. The “Child Lock” icon lights up (as shown in the diagram below).

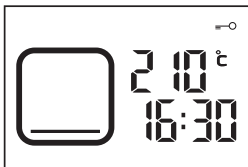

B. Cancelling the Child Lock:

Press and hold the “Child Lock” button for 3 seconds to disable the child lock function. The “Child Lock” icon goes off.

Cleaning and Maintenance

■ Cleaning and Maintenance

1. Under normal circumstances, cleaning is the only maintenance required.
2. Cleaning and maintenance should only be carried out when the combi steamer is cool and the  Residual Heat Indicator icon disappeared. Disconnect the power plug from the main power supply before cleaning. Do not use any steam cleaner to clean this appliance.
3. To avoid corrosion which would shorten the useful life of your combi steamer, always keep it clean. Always clean the appliance after use.
4. To avoid damage to the combi steamer body, control panel, oven walls and accessories, do not use any cleaning cloth that contains metal, scrubbing cleaners, steel brush or cloth with a rough surface for cleaning. Use a sponge or cloth soaked in gentle detergent or kitchen towel paper sprayed with glass cleaner to clean the appliance. Always make sure the cavity (including the bottom) is completely dried after use.
5. Salt is a corrosive substance that would result in rust stains if left to build up inside the oven. Acidic sauces, such as ketchup, mustard and preserves, contain chemicals like chlorine and acids which would damage the stainless steel surface.
6. Do not allow grease and food debris to remain on the oven door and door seal. If the door seal is not kept clean, the oven door may fail to close when the appliance is in operation. This would cause damage to the front and sides of the combi steamer.
7. After each use:
 - i) Empty the black drip tray under the oven door to prevent overflow, splash and soiling of the worktop. (The drip tray can be removed. It collects condensation water every time after use when door is opened)
 - ii) Empty the water tank.
 - iii) Always leave the door opened for 15-30 minutes or run the Cavity Drying Mode to dry the oven and door frame.
8. If the oven is very dirty, run the Sterilization Mode (110°C) to remove grease and dirt with steam for 30 minutes before cleaning. Do not start cleaning until the appliance has cooled down. For stubborn grease stains, repeat these steps several times. Never use any cleaning cloth that contains metal, scrubbing cleaners, steel brush or cloth with a rough surface for cleaning.
9. It is suggested to run the Descaling Mode at least once a month or when the descaling icon lights up.
10. Tap water, drinking water or distilled water is suggested for steaming function. Avoid using mineral water.
11. The water tank must be checked at least once a month. Clean it if necessary and put it back correctly.
12. Disconnect the main power if the appliance will not be used for a long period. Keep the oven clean and put the appliance in a dry place away from corrosive gases.
13. After every use, clean and air dry the oven (including the top, sides and bottom). If discoloration is detected at the bottom or inside the oven, remove the stains with a stainless steel cleaner (e.g. Wpro Steel Cleaner).

Cleaning and Maintenance

■ How to Lower the Upper Heater

1. Put your thumbs to press against the spring hock to the back until release and pull down the upper heater. Push back gently towards the arrow position as shown below.

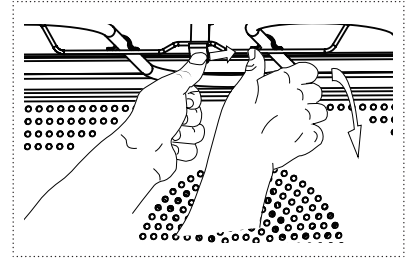
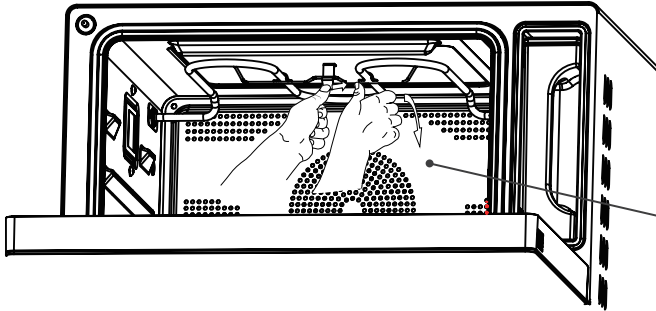

Put your thumbs to press against the spring hock to the back until release and pull down the upper heater. The heater can be lowered.

2. You can clean the top of the oven now (as shown in the diagram below).

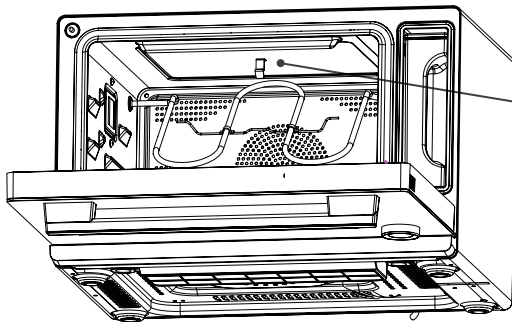

The heater can be lowered for easy cleaning.

3. After cleaning, gently press the upper heater upwards to snap into place.

Important:

1. Both thumbs and gentle force is required to press upwards for the steel bracket to easily lock into place.
2. Cleaning should only be carried out when the combi steamer is cool and the  Residual Heat Indicator icon disappeared.

Others

■ Troubleshooting

A. Possible Problems

	Problem	Cause	Solution
1	No Display	Combi steamer is not connected to power supply	Ensure it is connected to power supply
		Malfunction of power socket	Check if other electrical appliances work normally
		Power cords is not working	Contact after-sales service
2	Combi steamer is not working	Power supply plug is not connected correctly	Try to plug in the power supply again
		Oven door is not closed properly	Close the oven door again
		Water tank is not in a correct position	Put the water tank back correctly
		Circuit board is damaged	Contact after-sales service
		Child lock is enabled	Disable the child lock
3	Display is not working properly	Display is damaged	Contact after-sales service
		Circuit board is damaged	
4	Lots of Water or steam can be found during cooking	Oven door is not closed tightly	Close the oven door tightly again
		Door seal is damaged	Contact after-sales service
5	Oven light is not working	Light is damaged	Contact after-sales service
		Control board is damaged	
6	Fan motor fails to work properly	Fan motor is damaged	Contact after-sales service
		Control board is damaged	
7	Control panel is not working properly	Control panel is out of order	Contact after-sales service
		Control board is damaged	
8	No steam	Water tube is damaged	Contact after-sales service
		Water pump is damaged	
9	Water leakage	The water tank is not in a correct position	Fill the water tank and put it back correctly

Others

B. Following conditions are normal

	Condition	Cause
1	Fame and smell can be detected during the first time of use	These are emitted by the protective oil and it is normal.
2	Noise can be heard using any steam related mode	This is normal during water pumping into machine for steaming.
3	Water condensation can be found around the ventilation vent	The combi steamer produces a large amount of steam under steam cooking mode. Most of the steam will be vented from the frontal ventilation and some condensation water will be found around the ventilation vent.
4	The fan continues to work after cooking is finished	The fan will continue to run for 3 minutes after specific cooking functions for cooling purpose to discharge oven heat completely. It is normal.
5	White powder can be found around the air inlet	This is water scale. It is normal. If white powder (water scale) is detected, it is recommended to run the Descaling Mode for cleaning purpose.
6	Bottom and cavity of oven's color has yellowing.	Stainless steel will generate yellow marks when heated and not kept clean. It is recommended to clean the combi steamer after each use to avoid the yellowing issue caused.
7	Sound maybe created while closing the door during the cooking process or cooking is completed.	It is different pressure between room temperature and oven cavity. It is normal.
8	Water maybe spout out from air outlet while closing the door.	It is different pressure between room temperature and oven cavity. It is normal.

Others

■ Product Specifications

Model	CS1252A / CS1252B
Rated Voltage and Frequency	220-240V~ 50/60Hz
Rated Input Power	2100W
Product Dimension (H x W x D)	330 x 500 x 441 mm
Cavity Dimension (H x W x D)	220 x 366 x 309 mm
Oven Capacity	25L
Net Weight	Approximately 17 kg

Register your product online

網上登記新產品保養

香港 Hong Kong



Scan QR Code or visit
www.whirlpool.com.hk
to register your product warranty online.

You can download the user manual by:

- Visiting Our website **www.whirlpool.com.hk**
- Contacting our Customer Service at (852) 2406 9138.

掃描二維碼或登入
www.whirlpool.com.hk
以進行網上產品保養登記

可透過以下途徑下載使用說明書:

- 瀏覽我們的網頁 **www.whirlpool.com.hk**
- 致電我們的客戶服務中心 (852)2406 9138

新加坡 Singapore



Scan QR Code or visit
www.whirlpool.com.sg/warranty-registration
to register your product warranty online.

You can download the user manual by:

- Visiting Our website **www.whirlpool.com.sg**
- Contacting our Customer Service at (65) 6250 6888
or email **helpdesk.sg@whirlpool.com**

掃描二維碼或登入
www.whirlpool.com.sg/warranty-registration
以進行網上產品保養登記

可透過以下途徑下載使用說明書:

- 瀏覽我們的網頁 **www.whirlpool.com.sg**
- 致電我們的客戶服務中心 (65)6250 6888
或電郵至 **helpdesk.sg@whirlpool.com**

Whirlpool® Registered trademark/TM Trademark of Whirlpool group of companies
All rights reserved - <http://www.whirlpool.com.hk>

註冊商標/惠而浦集團的TM商標

版權所有 翻印必究 - <http://www.whirlpool.com.hk>

