

Whirlpool

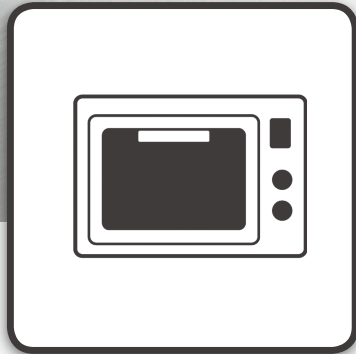

## Health & Safety, Use & Care, Installation Guide and Online Warranty Registration Information

產品安全指引、使用說明、安裝指南及  
網上登記保養資料

Model 產品型號：**MWP201EAS/MWP201EBS**



[www.whirlpool.com.hk](http://www.whirlpool.com.hk)

# INDEX

## INSTALLATION

Installation .....	3
--------------------	---

## SAFETY

Important safety instructions .....	4
Trouble shooting guide .....	5
Precautions .....	6

## ACCESSORIES AND MAINTENANCE

Accessories .....	7
Maintenance & Cleaning .....	8

## PRODUCT INSTRUCTION

Product Instruction .....	9
---------------------------	---

## CONTROL PANEL

Control Panel & Display Description.....	10
--	----

## GENERAL USE

Stand-by mode .....	11
Start Protection / Child Lock .....	11
Pause or Stop cooking .....	11
Add / Eco Stand-by mode / Stir / Turn food.....	11
Clock / Mute on/off .....	12

## COOKING FUNCTIONS

Jet Start .....	13
Microwave .....	14
Defrost.....	15
Dough Rising .....	16
Auto Cook.....	17
Soft/Melt .....	19
Keep Warm .....	20
Auto Clean .....	21
Popcorn.....	22

## ENVIRONMENTAL HINTS

Environmental Hints .....	23
Technical Specifications .....	23

# INSTALLATION

## PRIOR TO CONNECTING

Position the microwave oven at a distance from other heating sources. For sufficient ventilation, there must be a space of at least 30 cm above the microwave oven.

The microwave oven should not be placed in a cabinet.

This microwave oven is not intended to be placed or used on a working surface lower than 850mm above the floor.

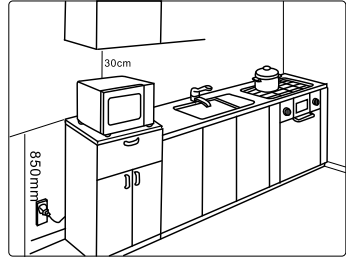

- \* Check if the voltage on the rating plate corresponds to the voltage in your home.
- \* Place the microwave oven on a stable and even surface that is strong enough to hold the microwave oven and the food utensils you put in it. Use carefully when handling.
- \* Ensure the space underneath, above and around the microwave oven is empty to allow for proper airflow.
- \* Ensure the appliance is not damaged. Check the microwave oven door is closed firmly against the door support and the internal door seal is not damaged. Empty the microwave oven and clean interior with a soft, damp cloth.
- \* Do not operate this appliance if it has a damaged mains cord or plug, if it is not working properly, or if it has been damaged or dropped. Do not immerse the mains cord or plug in water. Keep the cord away from hot surfaces. Electrical shock, fire or other hazards may result.
- \* Do not use an extension cord: If the power supply cord is too short, have a qualified electrician or serviceman install an outlet near the appliance.

## **⚠ WARNING:**

- \* **Improper use of the grounding plug can result in a risk of electric shock.**
- \* **Consult a qualified electrician or serviceman if the grounding instructions are not completely understood, or if you have doubts as to whether the microwave oven is properly grounded.**

## **ⓘ NOTE:**

Prior to using the microwave for the first time, it is recommended to remove the protective film from the control panel and the cable tie from the power cord.

## AFTER CONNECTING

- \* The microwave oven can be operated only if the microwave oven door is firmly closed.
- \* Poor television reception and radio interference may result if the microwave oven is located close to a TV, radio or aerial.
- \* The grounding of this appliance is compulsory. The manufacturer will accept no responsibility for injury to persons, animals or damage to objects arising from the non-observance of this requirement.
- \* The manufacturers are not liable for any problems caused by the user's failure to follow these instructions.

# SAFETY

## IMPORTANT SAFETY INSTRUCTIONS

### Read Carefully And Keep For Future Reference

- \* If material inside / outside the microwave oven ignite or smoke is emitted, keep microwave oven door closed and turn the microwave oven off. Disconnect the power or shut off power at the fuse or circuit breaker panel.
- \* Do not leave the microwave oven unattended, especially when using paper, plastic or other combustible materials in the cooking process. Paper can char or burn and some plastics can melt if used when heating foods.

### WARNING:

- \* If the door or door seals are damaged, the oven must not be operated until it has been repaired by a competent person.

### WARNING:

- \* It is hazardous for anyone other than a competent person to carry out any service or repair operation that involves the removal of a cover which provides protection against exposure to microwave energy.

### WARNING:

- \* Liquids and other foods must not be heated in sealed containers since they are liable to explode.

### WARNING:

- \* The appliance and its accessible parts become hot during use. Care should be taken to avoid touching heating elements inside the microwave oven.
- \* Children less than 8 years of age shall be kept away unless continuously supervised.
- \* The microwave oven is intended for heating foods and beverages. Drying of food or clothing and heating of warming pads, slippers, sponges, damp cloth and similar may lead to risk of injury, ignition or fire.
- \* This appliance can be used by children aged from 8 years and above, and persons with reduced physical, sensory or mental capabilities or lack of experience and knowledge if they have been given supervision or instruction concerning use of the appliance in a safe way and understand the hazards involved.
- \* Cleaning and user maintenance shall not be made by children unless they are aged from 8 years and above and supervised. Children should be supervised to ensure that they do not play with the appliance. Keep the appliance and its cord out of reach of children less than 8 years.
- \* Do not use your microwave oven for cooking or reheating whole eggs with or without shell since they may explode even after microwave heating has ended.

## **NOTE:**

**The appliance is not intended to be operated by means of an external timer or separate remote-control system.**

- \* Do not leave the microwave oven unattended if you are using a lot of fat or oil since they can overheat and cause a fire!
- \* Do not heat, or use flammable materials in or near the microwave oven. Fumes can create a fire hazard or explosion.
- \* Do not use your microwave oven for drying textiles, paper, spices, herbs, wood, flowers or other combustible materials as it may cause fire.
- \* Do not use corrosive chemicals or vapors in this appliance. This type of microwave oven is specifically designed to heat or cook food. It is not designed for industrial or laboratory use.
- \* Do not hang or place heavy items on the door as this can damage the microwave oven opening and hinges.

---

## TROUBLE SHOOTING GUIDE

---

## **NOTE:**

**If the microwave oven does not work, do not make a service call until you have made the following checks:**

- \* The Plug is properly inserted in the wall socket.
- \* The Door is properly closed.
- \* Check your Fuses and ensure that there is power available.
- \* Check the microwave oven has ample ventilation.
- \* Wait for 10 minutes, then try to operate the microwave oven once more.
- \* Open and then close the door before you try again.

This is to avoid unnecessary calls for which you will be charged.

When calling for Service, please give the serial number and type number of the microwave oven (see Service label).

Consult your warranty booklet for further advice.

If the mains cord needs replacing it should be replaced by the original mains cord, which is available via our service organization. The mains cord must only be replaced by a trained service technician.

## **WARNING:**

- \* **Service only to be carried out by a trained service technician.**
- \* **Do not remove any cover.**

# PRECAUTIONS

---

## GENERAL

**This appliance is intended to be used in household and similar applications such as:**

- \* Staff kitchen areas in shops, offices and other working environments;
- \* Farm houses;
- \* By clients in hotels, motels and other residential environments;
- \* Bed and breakfast type environments.

No other use is permitted (e.g. heating rooms).

## NOTE:

- \* The appliance should not be operated without food inside of it. Operation in this manner is likely to damage the appliance.
- \* The ventilation openings on the microwave oven must not be covered. Blocking the air intake or exhaust vents may cause damage to the microwave oven and poor cooking results.
- \* Whenever you are operating the microwave oven, always put a glass of water inside. The water will absorb the microwave energy and the microwave oven will not be damaged. Never operate with the empty unit.
- \* Do not store or use this appliance outdoors.
- \* Do not use this product near a kitchen sink, in a wet basement, or near a swimming pool, or similar area.
- \* Do not use the cavity for any storage purposes.
- \* Remove wire twist-ties from paper or plastic bags before placing bag in the microwave oven.
- \* Do not use your microwave oven for deep-frying, because the oil temperature cannot be controlled.
- \* Use hot pads or microwave oven mitts to prevent burns, when touching containers, microwave oven parts, and pans after cooking.

## LIQUIDS

**E.g. beverages or water. Overheating the liquid beyond boiling point can occur without evidence of bubbling. This could result in a sudden boil over of the hot liquid.**

To prevent this possibility the following steps should be taken:

- \* Avoid using straight-sided containers with narrow necks.
- \* Stir the liquid before placing the container in the microwave oven.
- \* After heating, allow standing for a short time, stirring again before carefully removing the container from the microwave oven.

## CAREFUL

**After heating baby food or liquids in a baby bottle or in a baby food jar, always stir and check the temperature before serving. This will ensure the heat is evenly distributed and the risk of scalding or burns can be avoided.**

# ACCESSORIES AND MAINTENANCE

## ACCESSORIES

---

- \* There are a number of accessories available in the market. Before you buy, ensure they are suitable for microwave use.
- \* Ensure the utensils you use are microwave oven proof and allow microwaves to pass through them before cooking.
- \* When you put food and accessories in the microwave oven, ensure they do not come in contact with the interior of the microwave oven. This is especially important with accessories made of metal or metal parts.
- \* If accessories containing metal come into contact with the microwave oven interior, while the microwave oven is in operation, sparking can occur and the microwave oven could be damaged.
- \* Metallic containers for food and beverage are not allowed during microwave cooking.
- \* For better cooking performance, it is suggested that you need to put the food in the middle of the turntable.



### GLASS TURNTABLE

Use the Glass Turntable with all cooking methods.

It collects dripping juices and food particles that otherwise would stain and soil the interior of the oven.

- Place the Glass Turntable on the Turntable Support.



### TURNTABLE SUPPORT

Use the Turntable Support under the Glass Turntable. Never put any other utensils on the Turntable Support.

- Fit the Turntable Support in the oven.

## MAINTENANCE & CLEANING

---

- \* Failure to maintain the microwave oven in a clean condition could lead to deterioration of the surface that could adversely affect the life of the appliance and possibly result in a hazardous situation.
- \* Do not use metal scouring pads, abrasive cleansers, steel-wool pads, gritty washcloths, etc. which can damage the control panel, and the interior and exterior microwave oven surfaces. Use a cloth with a mild detergent or a paper towel with spray glass cleaner. Apply spray glass cleaner to a paper towel.
- \* Use a soft and damp cloth with mild detergent to clean the interior surfaces, front and rear of the door and the door opening.
- \* Do not use steam cleaning appliances when cleaning your microwave oven.
- \* The microwave oven should be cleaned regularly and any food deposits should be removed.
- \* Cleaning is the only maintenance normally required. It must be carried out after the microwave oven being disconnected.
- \* Do not spray directly on the microwave oven.
- \* Do not allow grease or food particles to build up around the door.
- \* This product offers an AUTO CLEAN function, which allows for easy cleaning of the microwave cavity. For more details, please refer to the AUTO CLEAN section .



# PRODUCT INSTRUCTION

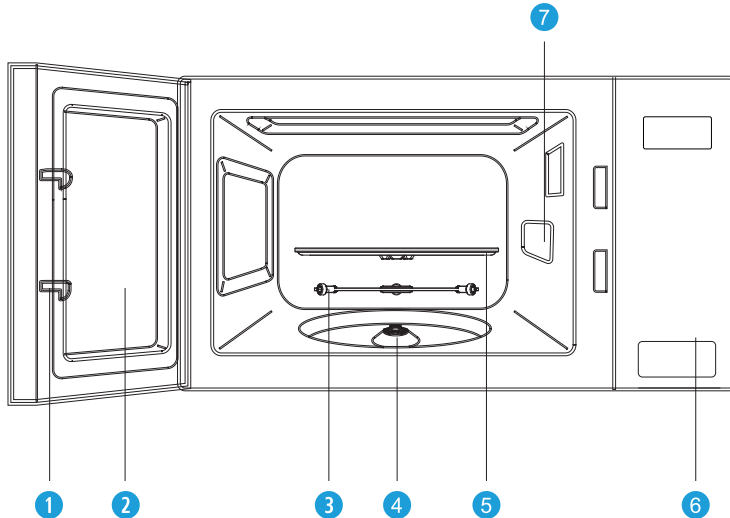

- ① Door lock  
Microwave oven door must be properly closed in order for it to operate
- ② Viewing window  
Allow user to see the cooking status
- ③ Turntable support  
The glass turntable sits on its wheels; it supports the turntable and helps it to balance when rotating
- ④ Rotating axis  
The glass turntable sits on the axis; the motor underneath it drives the turntable to rotate
- ⑤ Glass turntable  
The food sits on the turntable, its rotation during operation helps to cook food evenly

## **!** NOTE

- Place the turntable support first
- Fit the turntable onto the rotating axis and make sure it is geared in properly

- ⑥ Control Panel  
See below in details (the control panel is subject to change without prior notice)
- ⑦ Waveguide cover  
It is inside the microwave oven, next to the wall of control panel.

## **!** NOTE

Never remove the waveguide cover

# CONTROL PANEL& DISPLAY DESCRIPTION

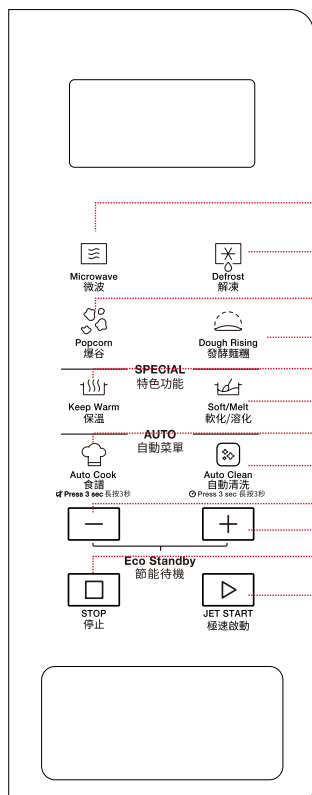

- ❶ Microwave - Use to set power level.
- ❷ Defrost - To set defrost programs.
- ❸ Popcorn - To set popcorn function.
- ❹ Dough Rising - Use to set Dough Rising function.
- ❺ Keep Warm - Use to set Keep Warm function.
- ❻ Soft/Melt.
- ❼ Auto Cook - Use to access the automatic recipes menu.  
Press 3 sec - Mute On/Off
- ❽ Auto Clean - Use to clean oven.  
Press 3 sec - Use to set clock.
- ❾ ❿ +/- - Use to input food menu code, clock time, cook time, cook weight.
- ⓫ STOP - Use to stop or cancel cooking.
- ⓬ JET START - Use to start cooking or 30sec Quick Start at Standby mode, or use to confirm selection.

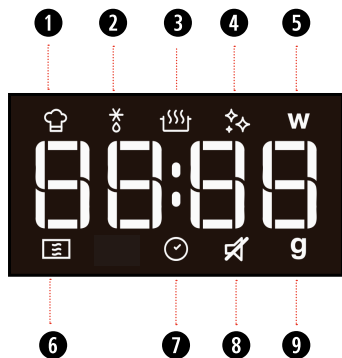

- ❶ Auto Cook Icon
- ❷ Defrost Icon
- ❸ Keep Warm Icon
- ❹ Auto clean Icon
- ❺ Microwave power (watt) Icon
- ❻ Microwave Icon
- ❼ Clock/Insert time Icon
- ❽ Mute On/Off Icon
- ❾ Weight (grams) Icon



## STAND-BY MODE / ECO STAND-BY MODE

---

The oven is in Stand-by mode when the clock is displayed (or, if the clock has not been set, when the display will show “:”).

**ECO STANDBY:** The function is set in order to save power. During Standby mode, you can press “+” and “-” buttons simultaneously to enter ECO STANDBY mode. In standby mode, the display will show time or “:” for 10 seconds then go to ECO STANDBY mode. Press “+” and “-” buttons together again to quit the mode.



## START PROTECTION / CHILD LOCK

---

This automatic safety function is activated one minute after the oven has returned to “Stand-by mode”.

When the safety function is active the door must be opened and closed in order to start the cooking, otherwise display will show “door”.

*door*



## PAUSE OR STOP COOKING

---

### To pause cooking:

The cooking can be paused to check, add or turn or stir the food by opening the door.

The setting will be maintained for 4 minutes.

The function will be stopped if STOP button is pressed during cooking.

### To continue cooking:

Close the door and press Jet Start button. The cooking is resumed from where it was paused.

### If you don't want to continue cooking you can:

Press STOP button and remove the food.

### When the cooking is finished:

The display will show text “End”. An acoustic beep will signal once every one minute for 10 minutes.

Please note reducing or stopping this programmed cooling cycle will not have a negative impact on the function of the product.



## ADD / STIR / TURN FOOD

---

Depending on the selected function, it could be needed to add / stir / turn food during cooking. In these cases, the oven will pause cooking and it will ask you to perform the needed action.

When required, you should:

- \* Open the door.
- \* Add or Stir or Turn the food (depending on the required action).
- \* Close the door and restart by pressing Jet Start button.

Notes: if the door is not opened within 4 minutes from the request to Add or Stir or Turn the food, the microwave oven will go to standby mode.

## ▶ Shortcut Guide

### Cook Time Setting Shortcut

\*For full power (800W) cooking only

Method 1:

Press "+" and hold until your desired cook time is reached, then press "▶" to start cooking

Method 2:

Press "▶" to start cooking for 30 sec first, then use "▶" key to add cook time at 30 sec interval, microwave oven will follow the new cook time to operate

### Add/ Reduce Cook Time during cooking

Using the two methods stated above can increase cook time when microwave is in operation. Cook time can also be reduced by pressing "-" during cooking

## 🔊 Mute On/Off

Press AUTO COOK for 3 sec to activate this function, and press 3 sec again to deactivate

## 🕒 CLOCK

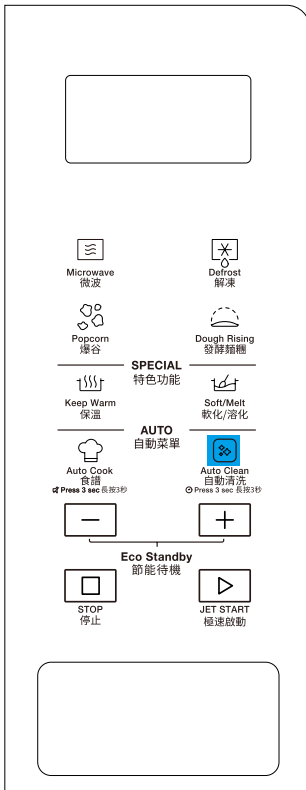

To SET THE CLOCK of your appliance:

- 1 In standby, press Auto Clean button for 3 seconds, then go to the Clock setting.
- 2 Press + / - to set the hour.
- 3 Press JET START button to confirm the hour.
- 4 Press + / - to set the minute.
- 5 Press JET START again to save Clock setting and return to standby mode.

### 📌 Tips and suggestions:

- When plug in, the screen shows "24Hr" ("24" flashing), use +/- to change 24 or 12 hour format, press JET START to confirm; then the screen shows "12:00".
- In the process of cooking set, press STOP button to cancel this program.
- In the process of cooking set, if no operation in 1 minute, system automatically return to standby mode.
- If the clock set is not correctly performed, the display show ":"

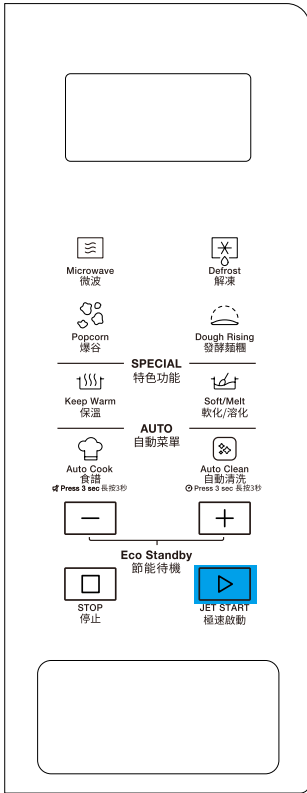

**THIS FEATURE ALLOWS YOU** to start the oven quickly. Press JET START button once, the oven starts to work at full power level. During cooking, press JET START to add time at 30 seconds interval. The longest cooking time is 90 minutes.

- 1 Press the JET START Button.

### ! NOTE:

Pressing JET START button, the Microwave function will start at full microwave power (800W) for 30 seconds.

### i Tips and suggestions:

- During the cooking it is not possible to change the cooking function but cooking time can be changed.
- To change the cooking time, please press +/- button. Or press the JET START button once to increase the duration time by 30 seconds.



# MICROWAVE

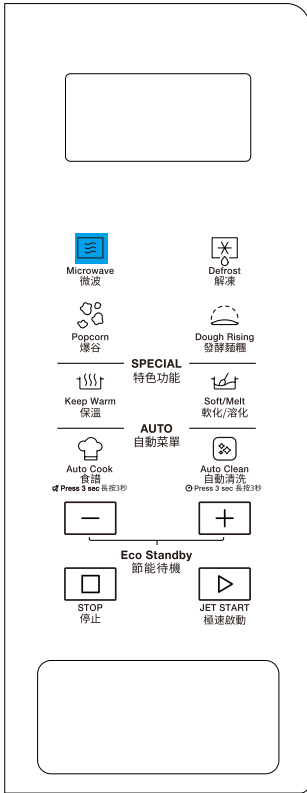

To cook with microwave power individually, press the Microwave button repeatedly to select a cooking power level, then press +/- button to set a desired cooking time. The longest cooking time is 90 minutes.

Suggested  
Accessory:

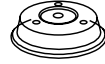

Plate Cover  
(sold separately)

- 1 Press the Microwave button. The default power level (750W) and microwave icon will be shown on the display and watt icon **W** starts blinking.
- 2 Press the Microwave button repeatedly or press +/- button to select suitable cooking power, then press JET START button.
- 3 Press + / - to set the cooking time, then press JET START button to start cooking.

## ! NOTE:

To select power, press the Microwave button again, the desired power level can be selected as below table.

POWER	SUGGESTED USE
90 W	Softening ice cream, butter and cheeses. Keep warm.
160 W	Defrosting.
350 W	Simmering stews, melting butter.
500 W	More careful cooking e.g. high protein sauces, cheese and egg dishes and to finish cooking casseroles.
650 W	Cooking for food no need to turn or stir.
750 W	Cooking for fish, meat or vegetable, etc.
800 W	Reheating of beverages, water, clear soups, coffee, tea or other food with a high water content. If the food contains egg or cream choose a lower power



# DEFROST

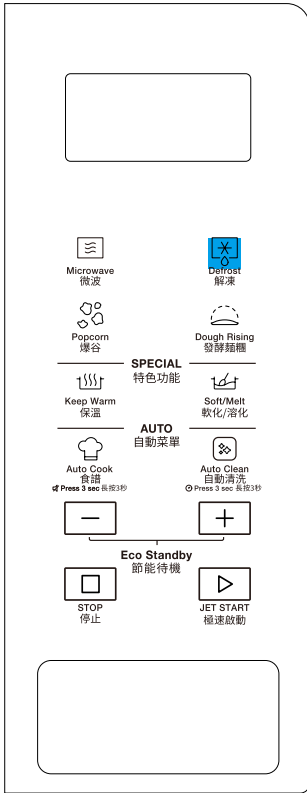

**USE THIS FUNCTION** for defrosting Meat, Poultry, Fish, and Vegetables.

- 1 Press Defrost button.
- 2 Press Defrost button repeatedly or +/- button to select food category in below table and press JET START to confirm.
- 3 For d01, press +/- button to set cooking time and press JET START button to start. For d02-d05, press +/- button to set the weight, and press JET START button to start.

	FOOD TYPE	WEIGHT	SUGGESTED USE
d01	Manual	/	
d02	Meat	100g - 2000g	Minced meat, cutlets, steaks or roasts. After cooking, allow food to rest for at least 5 minutes for better results.
d03	Vegetables	100g - 1000g	Larger, medium and small cut vegetables. Before serving, allow food to rest for 3-5 minutes for better results.
d04	Fish	100g - 2000g	Whole steaks or fish fillet. Allow food to rest for 5-10 minutes for better results.
d05	Poultry	100g - 2000g	Whole chicken, pieces or fillets. After cooking, allow food to rest for 5-10 minutes for better results.

## **i** Tips and suggestions:

- If the food is warmer than deep-freeze temperature (-18°C), choose a lower weight than the food.
- If the food is colder than deep-freeze temperature (-18°C), choose a higher weight than the food.
- Separate pieces as they begin to defrost. Individual slices defrost more easily.
- Standing time after defrosting always improves the result since the temperature will then be evenly distributed throughout the food.

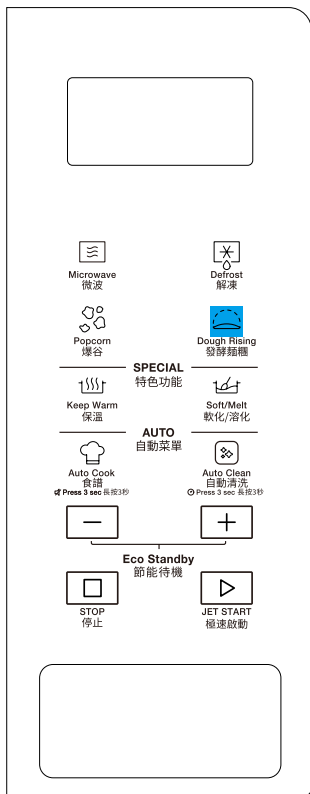

**THIS FUNCTION ALLOWS YOU** to have bread dough rising.

- 1 Put 200ml water into a container.
- 2 Place the container directly in the middle of the cavity.
- 3 Press the Dough Rising button.
- 4 Press the JET START button. The function will start

After 5min of water heating, the display show "Add"(if there is no operation for 4 minutes, it will automatically return to standby).

- 5 Open the door, remove the water container, put the dough onto the turntable.
- 6 Close the door, press JET START button to start .

## ! NOTE:

Don't open the door during count down.

The volume of the container should be at least 3 times of the dough.





# AUTO COOK

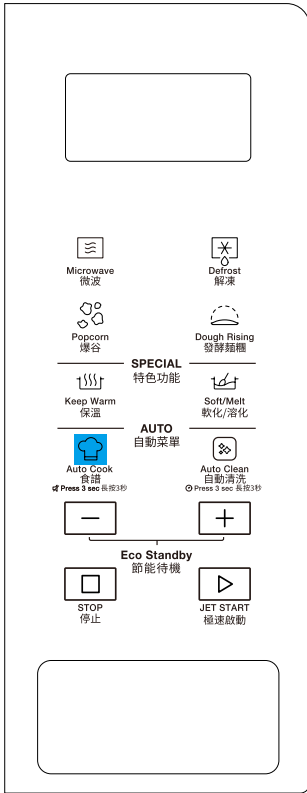







**A SELECTION OF AUTOMATIC RECIPES** with preset values to offer optimal cooking results.

- 1 Press Auto Cook button.
- 2 Press the Auto Cook button repeatedly or press +/- button to select the desired recipe (see the table following).
- 3 Press JET START button to confirm the recipe and press +/- button to select the weight within the weight range in the table.
- 4 Press the JET START button. The function will start.

**! NOTE:**





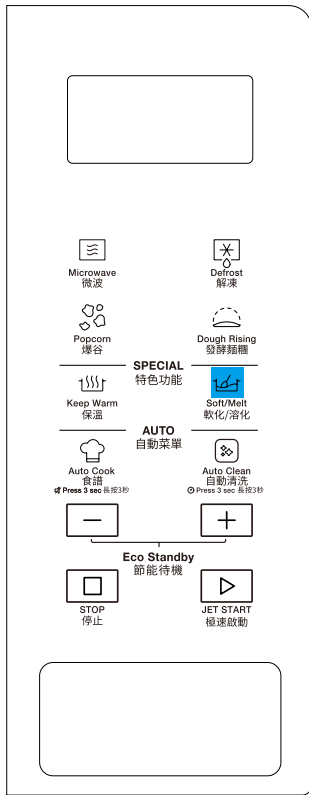



According to the selected recipe, after a certain time, the display would ask you to add or turn or stir the food. See "Add/Stir/Turn food" move to next row.

RECIPE	INITIAL STATE	WEIGHT	TIME	PREPARATION
P01  Yogurt	Room temperature	1000g	5Hr 20 min	Use boiled water to clean the container. Put 1000ml milk, 15g yogurt. Then add 50g sugar. Cover the container during cooking. Please do not open the door during the counting down.
P02  Cupcakes	Room temperature	8 cups (40g per cup)	4 min.	Put 125g eggs and 170g sugar into container then stir for 2-3mins,add 170g flour,10g baking powder ,100g water,50g butter, mix well,put food into the cups.Put the cups around the turntable to make sure uniform heat.
P03  Vegetable	Room temperature	200g, 400g, 600g	2min 30sec -6min.	Cut the vegetable into pieces,add 2 tablespoon water.
P04  Potato	Room temperature	250g, 500g, 750g	5min 30sec -16min.	Wash the potato, prick with fork, put it into the microwave-safe dish and place in the microwave. Select the needed potato quantity. Let stand 2-3 minutes after cooking.
P05  Pasta	Room temperature	50g, 100g, 150g	16min -22min.	Place Pasta into the plate and put in the microwave. Select the needed pasta quantity. Let stand 2-3 minutes after cooking.
P06  Pizza Reheat	Refrigerator temperature	200,400g	1min 40sec -3min 30sec.	Place pizza in the plate and put in the microwave. Select the needed pizza quantity. Let stand 2-3 minutes after cooking.
P07  Beverage	Room temperature	1,2,3 cups	1min 50sec -5min 45sec.	From room temperature. Pour 1-3 cups of beverage into the container and place in the microwave.



**A SELECTION OF AUTOMATIC RECIPES** with preset values to offer optimal cooking results.

- 1 Press Soft/Melt button.
- 2 Press the Soft/Melt button repeatedly or press +/- button to select the desired recipe (see the table below).
- 3 Press JET START button to confirm the recipe and press +/- button to select the weight within the weight range in the table.
- 4 Press the JET START button. The function will start.

FOOD TYPE		WEIGHT	HINT
SL01	Soften  Butter	50g - 500g/50g	From refrigerator state, unwrap and place in microwave safe dish
SL02	Soften  Ice Cream	100g - 1000g/50g	From frozen state, place ice cream container on turntable.
SL03	Soften  Cream Cheese	50g - 500g/50g	From refrigerator state, unwrap and place in microwave safe dish
SL04	Soften  Frozen Juice	250g - 1000g /250g	From frozen state, remove lid from container.
SL05	Melting  Butter	50g - 500g/50g	From refrigerator state, unwrap and place in microwave safe dish
SL06	Melting  Choco late	100g - 500g/50g	From room temperature, place in microwave safe dish.
SL07	Melting  Cheese	50g - 500g/50g	From refrigerator state, place in microwave safe dish.
SL08	Melting  Marsh mellow	100g - 500g/50g	From room temperature, place in microwave safe dish. The dish should be at least double volume with the marshmallows since they are expanded during cooking.

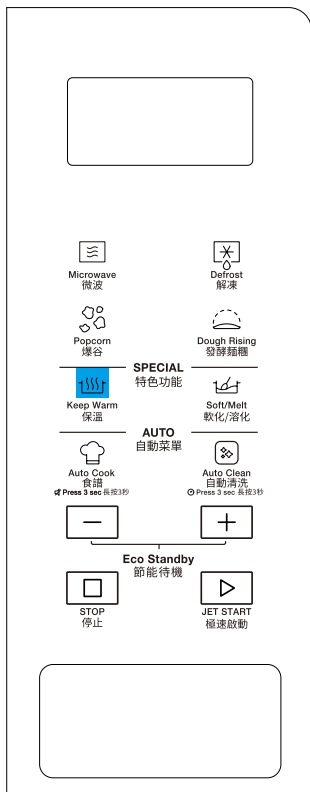

**THIS FUNCTION ALLOWS YOU** to keep your dishes warm.

Suggested Accessory:



Plate Cover(sold separately)

- 1 Press Keep Warm button.
- 2 Press the Keep Warm button repeatedly or +/- button to select suitable time (15, 30, 45 or 60 min), then press JET START button to start cooking.

## NOTE:

The keep warm cycle last for a duration of 15 minutes(default is 30 minutes), the maximum time is 60 min. Each 15 min cycle, microwave will be turned on 1:30 min.



## AUTO CLEAN

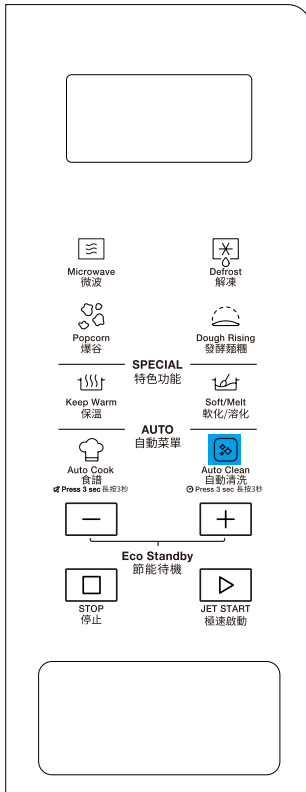

**THIS AUTOMATIC CLEANING** cycle will help you to clean the microwave oven cavity and remove unpleasant odors.

### Before starting the cycle:

- 1 Put 300ml water into a container (see our recommendations in below section "Tips and suggestions").
- 2 Place the container directly in the middle of the cavity.

### To Start The Cycle:

- 3 Press Auto Clean button, the cleaning cycle duration will be visible on the display.
- 4 Press Jet Start button to start the function.

### When The Cycle Is Finished:

- 5 Press Stop button.
- 6 Remove the container.
- 7 Use a soft cloth or a paper towel with mild detergent to clean the interior surfaces.

### Tips and suggestions:

- For a better cleaning result, it is recommended to use a container with a diameter of 17-20cm, and a height that is lower than 6.5cm.
- It is recommended to use a container of light plastic material that is suitable for the microwave.
- As the container will be hot after the cleaning cycle is completed, it is recommended to use a heat resistant glove when removing the container from the microwave.
- For a better cleaning effect and removal of unpleasant odors, add some lemon juice or vinegar to the water.



**USE THIS FUNCTION** for microwave popcorn from supermarket.

- 1 Press Popcorn button, display will show 100g and microwave icon will show on the display and watt icon starts blinking.
- 2 Press the Popcorn button repeatedly, or +/- to select weight between 100g and 80g.
- 3 Press JET START button to start cooking.

# ENVIRONMENTAL HINTS

- \* The packing box may be fully recycled as confirmed by the recycling symbol. Follow local disposal regulations. Keep potentially hazardous packaging (plastic bags, polystyrene, etc.) out of the reach of children.
- \* This appliance is marked according to the European directive 2012/19/ EU on Waste Electrical and Electronic Equipment (WEEE). By ensuring this product is disposed of correctly, you will help prevent potential negative consequences for the environment and human health, which could otherwise be caused by inappropriate waste handling of this product.
- \* The symbol on the product, or on the documents accompanying the product, indicates that this appliance may not be treated as household waste. Instead it shall be handed over to the applicable collection point for the recycling of electrical and electronic equipment.
- \* Disposal must be carried out in accordance with local environmental regulations for waste disposal.
- \* For more detailed information about treatment, recovery and recycling of this product, please contact your local city office, your household waste disposal service or the shop where you purchased the product.
- \* Before scrapping, cut off the mains cord so that the appliance cannot be connected to the mains.



## Technical Specification

Data Description	MWP201EAS/ MWP201EBS
Supply Voltage	230-240V~ 50Hz
Rated Input Power	1280 W
Outer dimensions (HxWxD)	264x456x326mm
Inner dimensions (HxWxD)	219x302x302mm
Net weight	11.3Kg

# 目錄

## 安裝指引

安裝指引	25
------	----

## 安全

重要安全注意事項	26
問題解決指南	27
注意事項	28

## 配件及維護

配件	29
維護保養及清潔	30

## 控制面板

控制面板說明	31
顯示說明	31

## 一般使用

待機模式	32
啟動保護/兒童鎖定	32
暫停或停止烹飪	32
添加/攪拌/翻轉食物	32
時鐘	33

## 烹飪功能

極速啟動	34
微波	35
解凍	36
發酵麵糰	37
食譜	38
軟化/溶化	40
保溫	41
自動清洗	42
爆谷	43

## 環境提示

環保建議	44
技術規格	44



# 安裝指引

## 接駁電線之前

請將微波爐放置在遠離熱源的地方。為了確保通風良好，微波爐頂部必須留有30厘米的空間。此爐必須背靠牆放置，確保微波爐底部，頂部及兩邊空氣流通。本爐具不應放置櫥櫃內使用。

本爐具不用於或放置在離地板少於850毫米以上的工作面上。

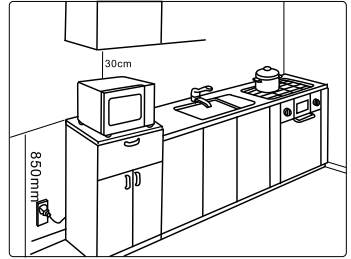

- \* 檢查銘牌上的電壓是否與您家中的電壓相符。
- \* 請將微波爐放置在平坦及穩固的地方，該處必須足以承托爐具與食物器皿的重量。放置時請務必小心。
- \* 確保微波爐底部，頂部及兩邊空氣流通。
- \* 確保微波爐沒有損壞。可檢查爐門關上時是否緊貼門框，以及內門的封邊是否完整無缺。將爐具內配件取出，然後用柔軟的濕布清潔爐具內部。
- \* 電線、插頭如有損壞，或爐具不能正常操作，或受到損壞或翻倒，則切勿使用微波爐。切勿將電線或插頭浸入水中，並避免接觸灼熱的表面，否則會引致觸電、火災或其他意外。
- \* 請勿使用延長線：如果電源線太短，請合格的電工或維修人員在設備附近安裝插座。
- \* 請不要移除爐腔內壁上的微波出口防護擋板，它們可以防止油脂或食物微粒進入微波孔中。

## ⚠ 警告：

- \* 接地插頭使用不當可能會導致觸電危險。
- \* 如果沒有完全了解接地指示，或者懷疑微波爐是否接地，請諮詢合格的電工或維修人員。

## ⚠ 注意：

首次使用微波爐之前，建議撕下控制面板上的保護膜，並把電源線上的紮帶移除。

## 連接之後

- \* 微波爐只能在爐門緊閉之後才能操作。
- \* 如將微波爐放置在電視機、收音機或天線附近，可能會影響接收或引起干擾。
- \* 此設備的接地是強制性的。製造商將不承擔由於不遵守這一要求而導致的人身，動物傷亡或財物損失的責任。
- \* 製造商不對由於用戶不遵守這些說明而導致的任何問題承擔責任。

# 安全

## 重要安全注意事項

仔細閱讀並保存以備將來參考

- \* 如果微波爐內部/外部的材料點燃或發出煙霧，請務必保持爐門關閉並關閉微波爐。斷開電源或切斷保險絲或斷路器面板上的電源。
- \* 不要讓微波爐在無人看管下操作，特別是在烹飪過程中使用紙張，塑料或其他易燃物品時，因為在加熱食物時，紙張會燒焦或燃燒，一些塑料會熔化。

### 警告：

- \* 如果門或閘的密封件損壞，不得操作此爐具，直到它由經過培訓的維修技術人員維修後。

### 警告：

- \* 除經過培訓的維修技術人員外，任何人對本產品的修復操作（如打開提供保護的外殼）都是危險的。

### 警告：

- \* 液體和其他食物不得在密封的容器中加熱。

### 警告：

- \* 本產品及其可觸及部件在使用過程中會變熱。應注意避免接觸微波爐內的加熱元件。
- \* 兒童應遠離本產品，除非在成人監督下使用。
- \* 微波爐主要用於加熱食品和飲料。食物或衣服的干燥以及變暖墊，拖鞋，海綿，濕布等的加熱可能導致受傷，著火或著火的危險。
- \* 該器具不可由兒童、身體感官或精神上能力不足，或經驗及知識不足的人士使用（包括兒童），除非監護其安全的負責人監督或指引其使用。
- \* 不應由兒童來清潔和進行日常的維護，除非他們被監督。兒童應受到監督，務必確保兒童不會把微波爐當作玩具。本品應盡量遠離兒童。
- \* 不要使用微波爐烹飪或加熱整個雞蛋，即使微波加熱結束它們也可能會爆炸。

## ! 注意:

- \* 本設備不用於外用的計時器或單獨遙控系統。
- \* 如果你使用大量的脂肪或油來煮食, 不要讓微波爐無人看管, 因為它們會過熱, 導致火災!
- \* 請勿加熱或使用微波爐內或附近的易燃材料。煙霧會造成火災或爆炸。
- \* 請勿使用微波爐烘乾紡織品、紙張、香料、草藥、木材、花卉或其他易燃材料。否則可能會導致火災。
- \* 請勿在本裝置中使用腐蝕性化學品或蒸氣。此微波爐是專門設計用來加熱或烹調食物的。它不是為工業或實驗室用途設計的。
- \* 請勿在門上懸掛或放置重物, 因為這會損壞微波爐的開啟和鉸鏈連接功能。

## 問題解決指南

---

## ! 注意:

若微波爐不能操作, 請檢查下列各項後才致電維修中心:

- \* 插頭是否完全插入插座。
- \* 爐門是否完全關閉。
- \* 檢查保險絲, 並確定已接上電源。
- \* 檢查微波爐是否有良好的通風環境。
- \* 等待十分鐘後再嘗試操作。
- \* 再作嘗試前, 請開啟爐門, 然後將其關上。
- \* 轉盤和轉盤托架是否就位。

以上檢查, 可避免不必要的檢查維修, 維修服務可能會收費。

致電維修服務中心時, 請提供機身編號及微波爐型號(請參閱維修服務標籤)。  
請參考您的保修手冊以得到進一步的建議。

若需更換電源線, 必須使用原廠產品, 並由接受過專業培訓的維修技師負責更換。  
有關的電源線可聯絡維修中心。

## ! 警告:

- \* 服務僅由訓練有素的服務技術人員執行。
- \* 不要移除任何防護蓋子。

## 注意事項

### 一般注意事項

**本產品只用於家庭和類似的場合，如：**

- \* 在商店、辦公室和其他工作環境中的工作人員廚房區域；
  - \* 農莊；
  - \* 客戶在酒店、汽車旅館等居住環境；
  - \* 床和早餐類型的環境。
- 不允許其他用途 (如暖氣室)。

### ! 注意：

- \* 本產品不應該在沒有食物的情況下進行操作。以這種方式操作可能會損壞設備。
- \* 微波爐的通風口不能被遮蓋。堵塞進氣口或排氣孔可能會造成微波爐損壞和烹調效果不佳。
- \* 如果你需要練習操作微波爐，可在裡面放一杯水。水會吸收微波能量，使微波爐不被損壞。注意參考下面“流質食物”內容。
- \* 請勿在戶外儲存或使用本產品。
- \* 請勿在廚房水槽附近、潮濕的地下室、游泳池附近或類似區域使用本產品。
- \* 請勿將爐腔用於任何存儲目的。
- \* 在將紙袋或塑料袋子放進微波爐前，需取下包裝的線扎。
- \* 不要用微波爐煎炸食物，因為難以控制油溫。
- \* 烹調後需使用熱墊或微波爐手套取出盛裝食物的盤子或容器，以防止接觸微波爐內側高溫物件導致燒傷。

### 流質食物

**用微波爐加熱的飲品或清水**，即使煮得過熱，甚至超過沸點，也未必會出現沸騰的氣泡，但是液體卻可能會突然溢出造成燙傷。

為了避免發生上述情況，請遵守下列幾點：

- \* 請避免使用窄頸的直身容器。
- \* 將流質食物放入爐內之前，請先加以攪拌，並將湯勺留在容器內。
- \* 流質食物加熱之後，請讓它留在爐內一會兒，再加以攪拌，才將容器小心拿出。

### ! 注意：

奶樽或嬰兒食物器皿中的食品或飲料加熱之後，在餵食之前，先將食物加以攪拌及測試食物的溫度，確保熱力分佈均勻，以避免燙傷或灼傷嬰兒。

請確保加熱前已將樽蓋與奶嘴取出！

有關詳細信息，請參閱微波烹飪書。特別是，如果烹飪或重新加熱含酒精的食物。

# 配件及維護

## 配件

- \* 市面上有很多配件可供選擇。在購買之前,需確保它們適合微波使用。
- \* 確保您使用的餐具是可使用於微波爐的,並可使微波穿透它們。
- \* 當你把食物和配件放進微波爐時,確保它們不會接觸微波爐內部。
- \* 使用金屬配件或金屬零件需特別注意。如果含有金屬的附件與微波爐內部接觸,而微波爐在運行時,會發生火花,微波爐可能會損壞。
- \* 微波爐烹調時不允許使用金屬容器盛裝食品和飲料。
- \* 為了得到更好的烹調效果,建議您把配件放在爐腔中間。

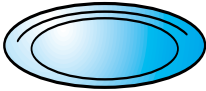

### 玻璃轉盤

所有烹飪方式都需要使用玻璃轉盤。它可以避免食物碎屑及肉汁沾污微波爐內腔。

- 將玻璃轉盤放在轉盤支架上。



### 玻璃轉盤支架

將轉盤支架放置在玻璃轉盤之下。不要把其他器具放在轉盤支架上。

- 在微波爐中安裝轉盤支架

- \* 未能將微波爐保持在乾淨的狀態可能會導致表面變質，從而對微波爐的壽命產生不利影響，並可能導致危險情況發生。
- \* 不要使用可能損壞控制面板，內部和外部表面的金屬擦洗墊，研磨性清潔劑，鋼絲刷，粗糙的抹布等。使用混合溫和洗滌劑的布或用噴霧玻璃清潔劑的紙巾。將噴霧玻璃清潔劑塗抹在紙巾上再進行清潔。
- \* 使用柔軟的濕布和溫和的清潔劑清潔爐腔內壁、爐門前後、門封以及開門位置。
- \* 清洗微波爐時不要使用蒸汽清潔設備。
- \* 微波爐應定期清洗，並去除任何食物沉積物。
- \* 微波爐只要勤加清潔，便是最佳的維護方法。但在清潔前，必須關掉電源。
- \* 不要直接噴在微波爐上。
- \* 該微波爐設計用於使用適當的容器在平坦的腔體進行烹飪操作。
- \* 不要讓油脂或食物微粒在門附近及爐腔內壁上的微波出口防護擋板上殘留。
- \* 該產品提供自動清洗功能，可方便地清洗爐腔。有關詳細資訊，請參閱41頁上的自動清洗部分。

# 控制面板和顯示說明

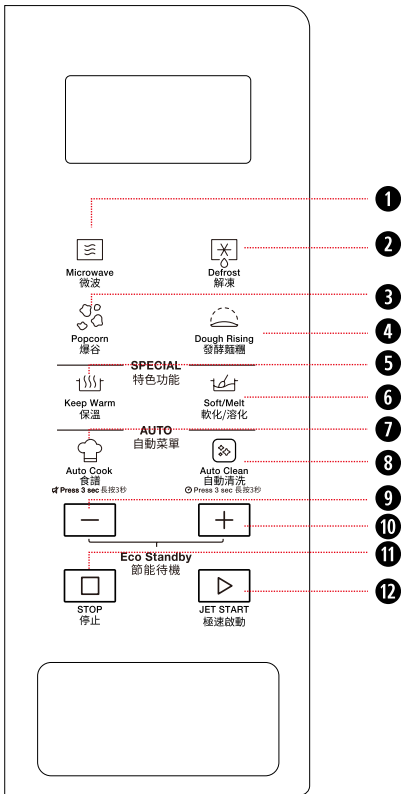

- ❶ 微波  
用來設置微波火力。
- ❷ 解凍  
設置解凍菜單。
- ❸ 爆谷  
設置爆谷菜單。
- ❹ 發酵麵糰  
設置發酵菜單。
- ❺ 保溫  
設置保溫程序。
- ❻ 軟化/溶化  
按此掣進入軟化或溶化模式。
- ❼ 食譜  
用於選擇自動食譜菜單。  
長按3秒-用於設置靜音或取消靜音
- ❽ 自動清洗-用來清潔腔體。  
長按3秒-用於設置時間。
- ❹ ❿ +/-  
用於選擇食物菜單代碼，時鐘時間，  
烹飪時間，烹飪重量。
- ❾ 停止  
用來停止或取消烹飪。
- ❿ 極速啟動  
用來開始烹飪。  
用於設置極速啟動程序。

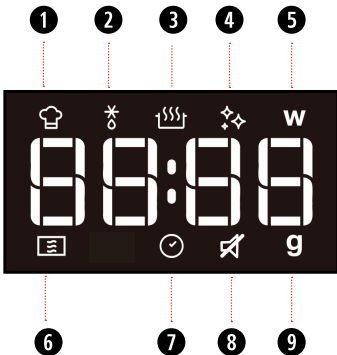

- ❶ 食譜圖標
- ❷ 解凍圖標
- ❸ 保溫圖標
- ❹ 自動清洗圖標
- ❺ 微波火力
- ❻ 微波圖標
- ❼ 輸入時間
- ❽ 靜音
- ❹ 重量

## 待機模式

當顯示時鐘時，微波爐處於待機模式（如果時鐘未設置，顯示屏將顯示“: ”）。節能待機的功能設置是爲了節約電能，在待機模式下，您可以同時按“+”和“-”鍵，進入待機模式。待機模式下，顯示屏將顯示時間或“: ”十秒鐘，然後進入節能模式，再次同時按下“+”和“-”鍵，退出模式。

## 啟動保護/兒童鎖定

此自動安全鎖功能會在微波爐回復“待機”模式後的1分鐘後啟動。安全鎖必須在爐門開啟及關閉之後（例如將食物放入爐中）才會解開。如果您沒有打開門再關上便開始操作微波爐的話，顯示屏會顯示DOOR（爐門）的字樣：

*door*

## 暫停或停止烹飪

要暫停烹飪：

可以暫停烹飪以檢查烹調情況，通過打開爐門來轉動或攪拌食物。暫停設置可保持4分鐘。

烹飪過程中如按停止掣將停止工作。

繼續烹飪：

關閉爐門，然後按極速啟動掣一次。烹飪從暫停的地方恢復。

如果你不想繼續烹飪，你可以：

取出食物，關上爐門，然後按停止掣。

烹飪完成後：

顯示屏將顯示“End”。嗶聲響將每分鐘發出一次信號，持續2分鐘。

請注意，減少或停止此編程冷卻循環不會對產品的功能產生負面影響。

## 添加/攪拌/翻轉食物

根據所選功能，可能需要在烹飪期間添加/攪拌/翻轉食物。在這些情況下，微波爐將暫停烹飪，它會要求您執行所需的操作。

需要時，您應該：

- 1 打開爐門。
- 2 添加/攪拌/翻轉食物（取決於所需的動作）。
- 3 關閉爐門，然後按極速啟動掣重新啟動。

注意：如果在要求添加、攪拌或翻轉食物之後4分鐘內爐門沒有打開，微波爐將進入待機模式。



## ▶ 簡易操作提示

### 煮食時間設置快捷鍵

\*僅適合用於最高火力（800W）煮食

方法1:

按住“+”鍵直至屏幕顯示需要的煮食時間，然後按“▶”鍵開始煮食

方法2:

按“▶”鍵一次開始煮食30秒，然後按“▶”鍵增加煮食時間，每按一次增加30秒煮食時間（最多90分鐘）

### 煮食途中增加或減少煮食時間

微波爐煮食途中可以用以上兩種方法增加煮食時間，煮食途中可以按“-”鍵減少時間。

## 🔇 靜音/取消靜音

長按“食譜”鍵3秒設置靜音，再次長按3秒取消靜音。

## 🕒 時鐘

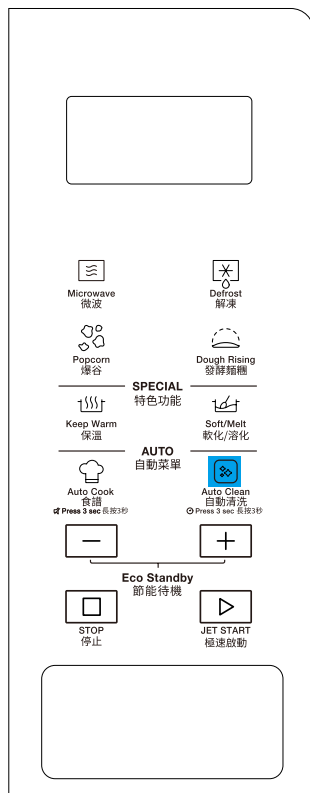

### 時鐘設置功能

- 1 待機狀態下，持續按自動清洗掣3秒，顯示屏將顯示當前時間。
- 2 按+/-掣設置小時數位。
- 3 按自動清洗/極速啟動掣，確定小時設定。
- 4 按+/-掣設置分鐘數位。
- 5 按自動清洗/極速啟動掣，確定最終設定。

### 📌 提示和建議:

- 本產品插上電源時，螢幕顯示"24:00" ("24"閃爍)，按+/-鍵轉換24或12小時制，然後按"極速啟動"鍵確認后，螢幕會顯示"12:00"。
- 在烹飪過程中，按下停止掣以取消該程式。
- 在烹飪設定過程中，若1分鐘內沒有任何後續操作，系統自動返回到待機模式。
- 如果沒正確設置時鐘，螢幕會顯示":."。

## ▶ 極速啟動

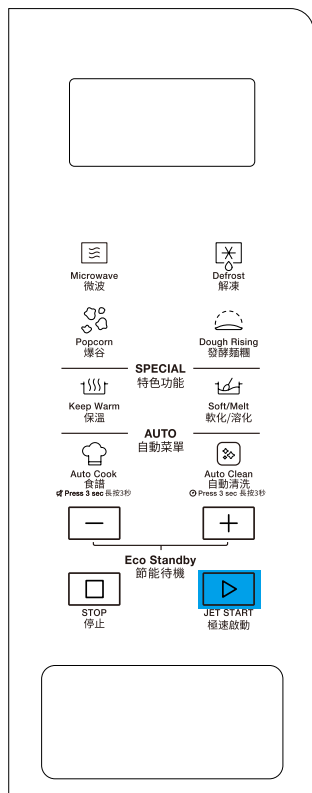

此功能允許您快速啟動微波爐。按下極速啟動掣一次，微波爐自動開始工作（全火力狀態）。烹飪過程中，可按極速啟動掣增加時間。烹調時間最長為90分鐘。

- 1 按極速啟動掣。

### ! 注意：

按極速啟動掣，微波功能將會以全火力狀態（800W）工作30秒。

### i 提示和建議：

- 即使在烹飪過程已經開始，也可以更改微波火力和煮食時間，只需反覆按下微波掣即可。
- 要更改煮食時間，請按 +/- 掣。或按一次極速啟動掣，將持續時間延長30秒。

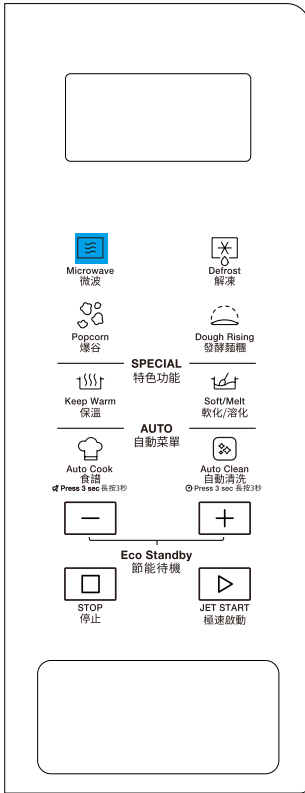

使用不同的微波火力進行烹調,可反覆按下微波擊選擇一個烹飪火力,然後按 +/-擊,以設置一個理想的烹調時間。烹調時間最長為90分鐘。

專用配件:

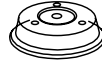

盤蓋  
(需另外購買)

- 按微波擊,默認的微波火力(750W)和微波圖標 會顯示於顯示屏上,同時微波火力圖標 **W** 閃爍。
- 反覆按微波擊或按 +/-擊選擇合適的煮食功率,然後按極速啟動擊。
- 按 +/- 擊設置煮食時間,然後按極速啟動擊開始烹調。

## ! 注意:

如果需要更改烹調火力,請再次按下微波擊,選擇所需的火力,選擇如下表所示。

火力	建議用於
90 W	軟化雪糕、牛油及芝士。保持溫暖。
160 W	解凍。
350 W	蒸燉食物,融化牛油。
500 W	烹調需要較小心處理的食物,例如含豐富蛋白質的醬汁、芝士及雞蛋菜式,以及可以烹調煲仔菜。
650 W	烹飪無需翻轉的菜餚。
750 W	烹飪魚類,肉類,蔬菜等。
800 W	重新加熱飲料,水,清湯,咖啡,茶或其他高含水量食物。如果食物含有雞蛋或忌廉,選擇較低的功率。

# ❄️ 解凍

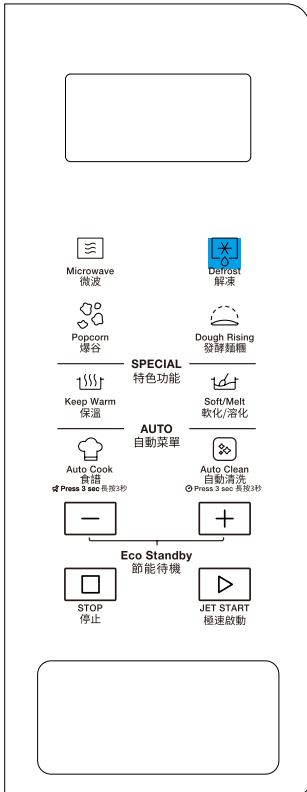

這個功能可以讓你解凍肉類/家禽/魚類和蔬菜。

- 1 按解凍掣。
- 2 反覆按解凍掣或按 +/- 掣選擇所需的菜單 (請參閱下表)。
- 3 按 +/- 掣調整食物的重量，再按極速啟動掣啟動。

食物類別	份量	建議
d01	❄️ 手動解凍	/
d02	🥩 肉類	100克 - 2000克 肉碎，肉餅，牛排或烤肉。 解凍後放置5分鐘才開始煮食，效果最佳。
d03	🥬 蔬菜	100克 - 1000克 大，中，小件蔬菜。 解凍後放置3-5分鐘才開始煮食，效果最佳。
d04	🐟 魚類	100克 - 2000克 一整塊魚排或魚柳。 解凍後放置5-10分鐘才開始煮食，效果最佳。
d05	🐔 家禽	100克 - 2000克 整隻雞，雞塊或雞片。 解凍後放置5-10分鐘才開始煮食，效果最佳。

## ❗ 提示和建議：

- 如果食物比冷凍溫度(-18° C) 更高， 選擇比食物更低的重量。
- 如果食物比冷凍溫度(-18° C) 更低， 選擇比食物更高的重量。
- 切塊解凍效果更好。
- 解凍後的工作時間可改善煮食效果， 因為溫度將均勻分佈在整個食品。

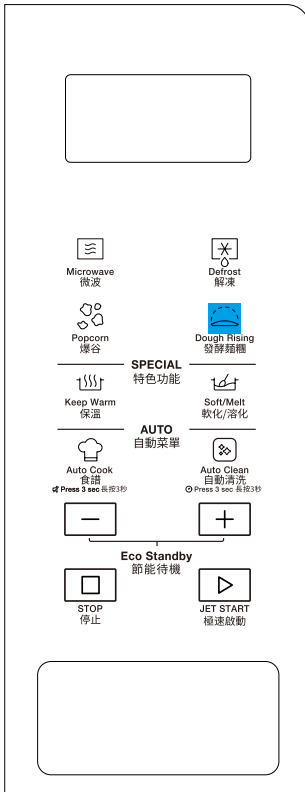

這個功能可以讓你發酵食物。

- 1 按發酵麵糰掣。
- 2 放置200毫升水到容器中。
- 3 將容器放置到爐腔正中心位置。
- 4 按極速啟動掣，啟動該功能。

時間倒數至45分鐘時候，顯示屏會顯示“Add”（如4分鐘內無任何操作將自動跳轉至待機狀態）。

- 5 打開爐門，移除容器，將需發酵的食物放置到玻璃轉盤上。
- 6 關閉爐門，按極速啟動掣啟動工作。

## ！ 注意：

在計時完結前請勿打開爐門。

容器的體積需要是需發酵食物的三倍以上。

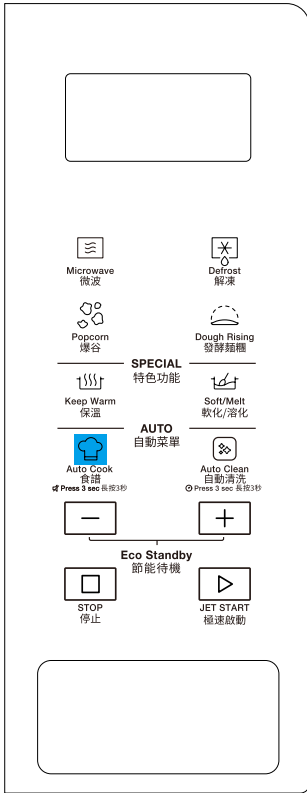

選擇具有預設值的食譜，以提供最佳烹飪效果。

- 1 按食譜掣。
- 2 反覆按食譜掣或按+/-掣選擇所需的菜單（請參閱下表）。
- 3 按極速啟動掣確認菜單，並按下+/-掣選擇表中重量範圍內的重量。
- 4 按極速啟動掣，啟動該功能。

### ！ 注意：

根據選定的菜單，一段時間後，顯示屏會要求您添加或轉動食物。詳見第32頁的“添加/攪動/翻轉食物”一節。

菜單	起始狀態	重量	時間	準備工作
P01  乳酪	室溫	1000克	5小時 20分鐘	按下乳酪掣。將1000克牛奶和15克乳酪放入容器中，加入50克糖，攪拌均勻，並放入到腔體中間。
P02  杯子蛋糕	室溫	8杯 每杯40g	4分鐘	將 125 克雞蛋和 170 克糖放入容器中攪拌 2-3 分鐘，加入 170 克麵粉，10 克發酵粉，100 克水，50 克牛油，將食物放入紙杯中。將紙杯放在轉盤四周，確保加熱均勻。
P03  蔬菜	室溫	200克，400克 600克	2分鐘30秒 -6分鐘	把蔬菜切成塊，加2 湯匙水。
P04  馬鈴薯	室溫	250克，500克 750克	5分鐘30秒 -16分鐘	清洗馬鈴薯，用叉子戳開，將馬鈴薯放在微波爐用的容器中，將容器放入微波爐。選擇馬鈴薯重量。煮食完成2-3分鐘后再拿出。
P05  意面	室溫	50克，100克 150克	16-22分鐘	將意面放在盤子后放入微波爐。選擇意面重量。煮食完成2-3分鐘后再拿出。
P06  披薩	冷凍	200克，400克	1分鐘40秒 -3分鐘30秒	將披薩放在盤子后放入微波爐。選擇披薩重量。煮食完成2-3分鐘后再拿出。
P07  飲料	室溫	1，2，3杯	1分鐘50秒 -5分鐘45秒	室溫狀態下將飲料倒入杯中，然後將杯放入微波爐。

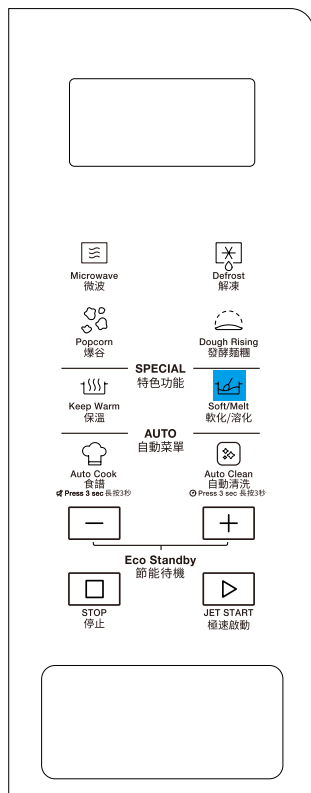

選擇自動菜單與預設值提供最佳的烹調結果。

- ① 按軟化/溶化掣。
- ② 重覆按軟化/溶化掣或按 +/-掣來選擇特定的煮食菜單 (請參閱下表)。
- ③ 按極速啟動掣確認菜單, 同時在需要選擇重量的菜單按 +/-掣選擇重量。
- ④ 按極速啟動掣啟動該功能。

食物類型		重量	提示
SL01	軟化	牛油 50-500 克 /50 克	從雪櫃取出, 打開包裝並放置於適用於微波爐的盤子上。
SL02	軟化	雪糕 100-1000 克 /50 克	冷凍狀態, 把雪糕容器放置於玻璃盤上。
SL03	軟化	忌廉芝士 50-500 克 /50 克	從雪櫃取出, 打開包裝並放置於適用於微波爐的盤子上。
SL04	軟化	冰凍果汁 250-1000 克 /250 克	冷凍狀態, 從容器中拿走蓋子。
SL05	溶化	牛油 50-500 克 /50 克	從雪櫃取出, 打開包裝並放置於適用於微波爐的盤子上。
SL06	溶化	朱古力 100-500 克 /50 克	室溫下, 放置於適用於微波爐的盤子上。
SL07	溶化	芝士 50-500 克 /50 克	從雪櫃取出, 放置於適用於微波爐的容器內。
SL08	溶化	棉花糖 100-500 克 /50 克	室溫下, 放置於適用於微波爐的容器內. 該容器必須至少大於棉花糖兩倍因為在烹調過程中棉花糖會膨脹。



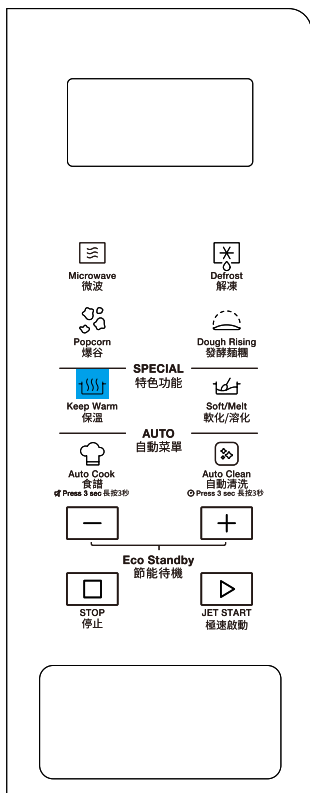

此功能可保持菜餚的溫度。

專用配件： 盤蓋  
(需另外購買)

- 1 按保溫掣。
- 2 按 + / - 掣選擇適用的時間（15，30，45 或者60分鐘），然後按極速啟動鍵開始。

## ! 注意：

保溫週期為 15分鐘，(默認時間為30分鐘) 為確保保持良好的效果, 請選擇多於15分鐘的保溫時間。  
每15分鐘為一周期，微波爐會在1分30秒時運行，會有倒數時間顯示。

## 自動清洗

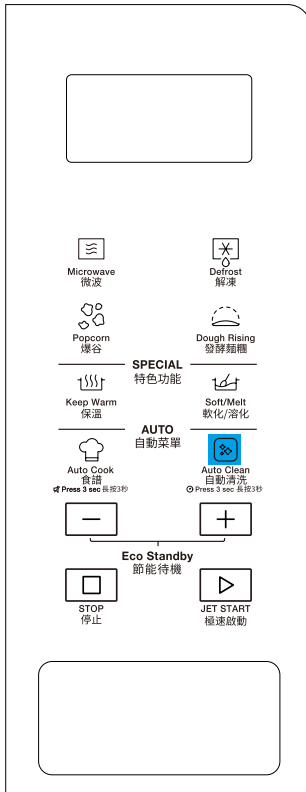

此自動清洗功能將幫助您清潔微波爐腔，並消除不潔的氣味。

開始自動清洗之前：

- 1 將300毫升水倒入容器中（請參閱下文“提示和建議”一節中的建議）。
- 2 將容器直接放在玻璃轉盤上。

開始自動清洗：

- 3 按一次自動清洗掣，清洗循環持續時間將顯示在顯示屏上。
- 4 按極速啟動掣啟動該功能。

當清洗循環完成時：

- 5 按下停止掣。
- 6 取出容器。
- 7 使用軟布或帶有溫和洗滌劑的紙巾清潔爐腔。

**i** 提示和建議：

- 為了得到更好的清潔效果，建議使用直徑為17-20厘米和高度低於6.5厘米的容器。
- 建議使用適用於微波爐的輕質塑膠材料容器。
- 當清洗週期完成後，容器將是熱的，建議從微波爐中取出容器時使用耐熱手套。
- 若想達到更好的清潔效果和去除不潔的氣味，可在水裡加一些檸檬汁或醋。

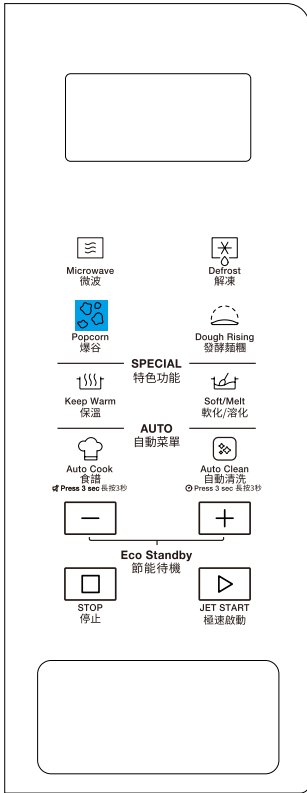

此功能用於在超市購買的微波爐專用爆谷

- 1 按爆谷鍵，熒幕會顯示100g，微波圖標會在熒幕上顯示，火力圖標會開始閃爍。
- 2 重複按爆谷鍵,或+/-鍵從80和100克中選擇重量。
- 3 按極速啟動鍵啟動工作

## 環保建議

- 用來盛載本爐具的紙盒印有環保標誌，可以完全循環再造。棄置有關包裝材料時，請遵循本地的廢物棄置條例。請把可能引致危險的包裝材料（如膠袋、發泡膠等）放置在小孩接觸不到的地方。
- 本產品依照歐洲關於廢棄電子電氣產品條例2002/96/EC 進行標識(WEEE)。  
。用戶正確棄置能夠幫助預防對環境及人類健康潛在的負面影響。
- 產品上或產品檔上的此標誌表示本產品有可能不屬於家庭棄置廢物。需要將其交至指定的電子電氣產品廢置站。
- 本產品如日後需要棄置，請遵循本地的廢物棄置條例。
- 有關產品處理，恢復及循環使用的詳細資料，請諮詢本地政府機構，家庭棄置廢物機構或購買產品的商鋪。
- 棄置前請切斷電源線，使本產品不能連接電源。



## 技術規格

數據描述	MWP201EAS/ MWP201EBS
電源電壓	230-240V~ 50Hz
額定輸入功率	1280 W
機身尺寸 (高x寬x深)	264x456x326mm
爐腔尺寸 (高x寬x深)	219x302x302mm
淨重	11.3Kg







# Register your product online

## 網上登記新產品保養

Save the planet and register your product warranty online!  
Enjoy extra 1-month free warranty upon online registration.

「惠」環保出力，減少用紙！於網上登記產品更可獲額外多一個月保養。



<https://rebrand.ly/WPwarranty>

Whirlpool® Registered trademark/TM Trademark of Whirlpool group of companies

All rights reserved - <http://www.whirlpool.com.hk>

註冊商標/惠而浦集團的TM商標

版權所有 翻印必究 - <http://www.whirlpool.com.hk>



---

