

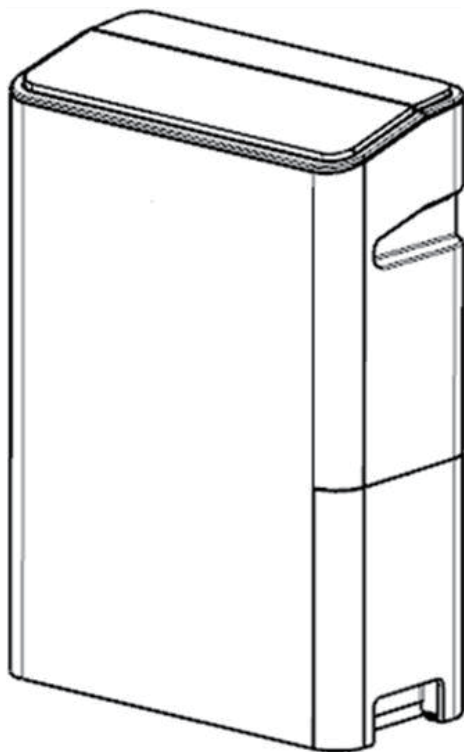

抽濕機使用說明書

Household Dehumidifier Operating Instructions

產品型號 Model : DS201NB / DS201NT
DS241NB / DS241NT



- 感謝您購買惠而浦抽濕機
- 使用前請仔細閱讀本使用說明書
- 請妥善保管，以備查閱
- 熟練使用，有利節約

- Thank you for choosing our products
- Please read this instruction carefully before use
- Please keep this instruction for future reference
- Proficient use to save electricity

尊敬的用戶：





感謝您購買惠而浦抽濕機，我們將竭誠為您提供無憂服務。方便您的居家生活。

請仔細閱讀本使用說明書，並妥善保管，以備日後查閱、維修。

因公司產品不斷改進，如有更改，恕不另行通知。

目錄

產品概述	產品特點	1
	產品簡圖(正面)	2
	產品簡圖(背面)	3
	控制面板	4-5
安全注意事項	安全標誌	6-7
	注意事項	8-10
使用準備	包裝卸除	11
	檢查水箱	11
	安裝位置	12
	操作條件	12
操作方法	抽濕模式	13
	乾衣模式	14
	第 6 感智能模式	14
	夜間模式	15
	負離子淨化裝置	16
	兒童安全鎖	16
	排水提示	16
	導風板設定	17
連續排水	17	
空氣淨化系統	過濾網	18
	負離子淨化裝置	19
保養及維修		20-21
故障與排除		22-23
規格表		24

	<p>第 6 感智能模式 — 惠而浦的第 6 感智能控制系統，能夠利用智能濕度感測功能，來感測周邊環境濕度的改變；使風扇可即時調節適當的風速。</p>
	<p>抽濕模式 — 風速及運行時間可通過個人設置來進行調整。</p>
	<p>乾衣模式 — 以最高的風速來進行乾衣，不單只合適用於潮濕的季節，亦適合於全年使用。</p>
	<p>夜間模式 — 摩打和風速以超低的速度運行，亦能夠令空氣淨化，造就一個寧靜和舒適的環境。</p>

產品概述

抽濕機簡圖 (正面)

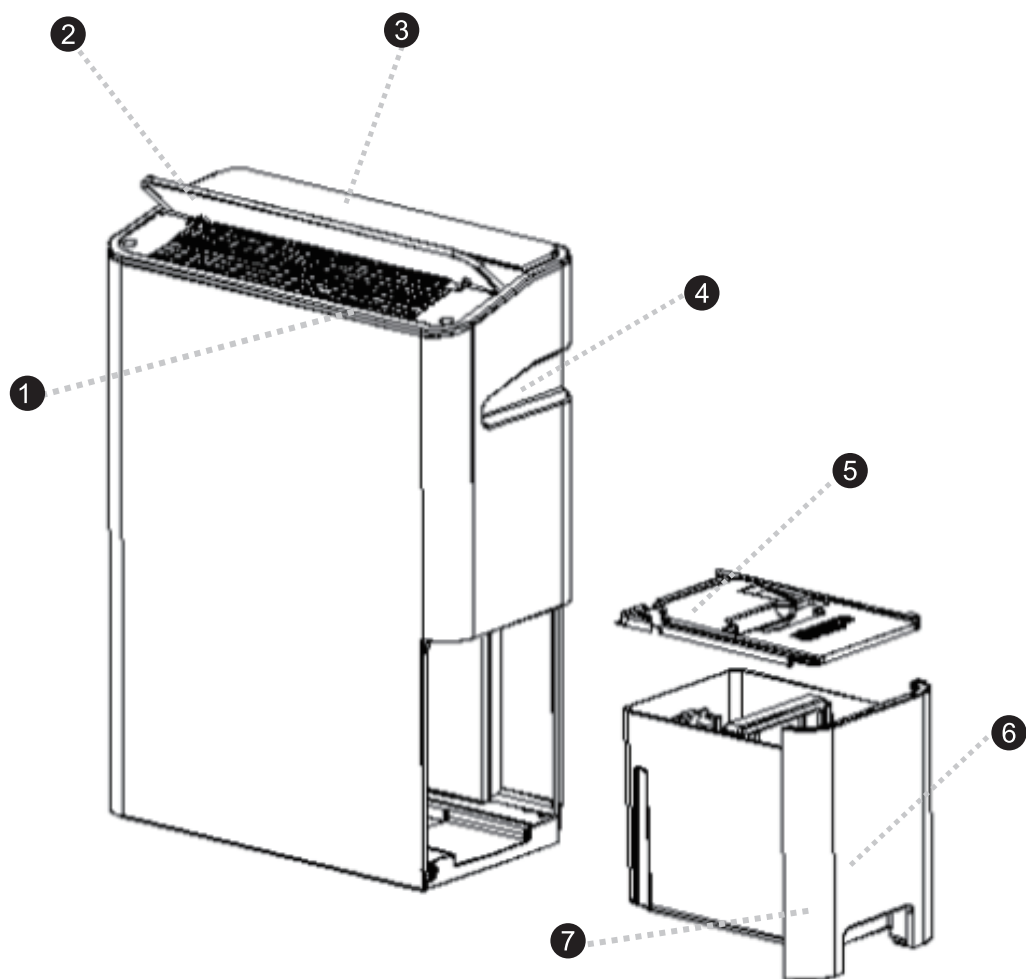

1. 導風板左右擺動調節鈕

2. 導風板

3. 控制面板

4. 隱藏式把手

5. 水箱防漏蓋

6. 水箱

7. 水位顯示位置

抽濕機簡圖 (背面)

型號：DS201NB/DS201NT/DS241NB/DS241NT

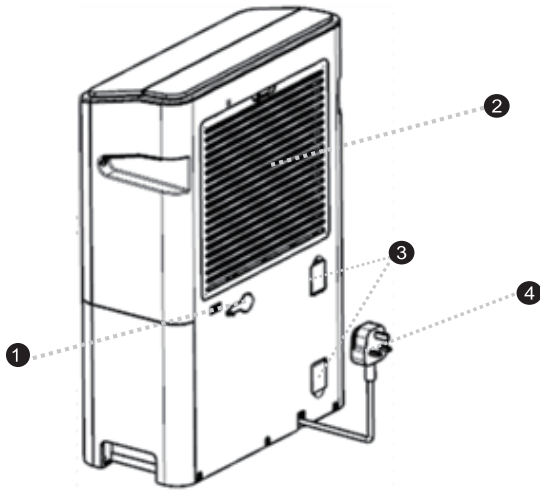

1. 連續排水端蓋
2. 背板 (* 前置濾網)
3. 電源線座
4. 電源插頭

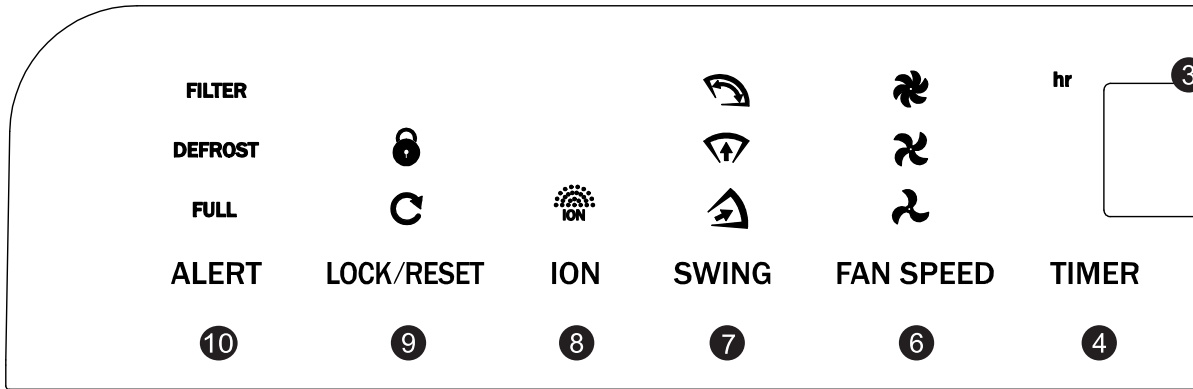

* 20L 及 24L 前置濾網：納米銀離子濾網

控制面板

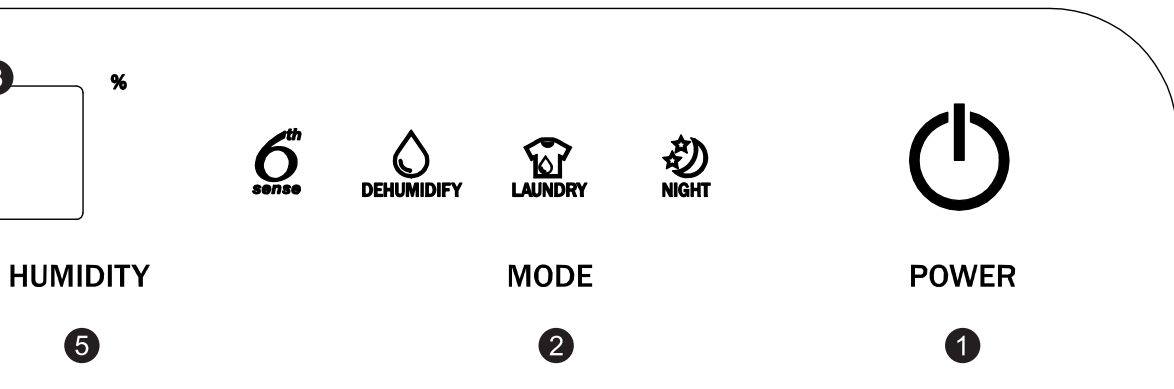

1. 開 / 關鍵
啟動 / 停止操作
2. 模式鍵
選擇 6 種不同模式包括
第 6 感智能模式 (頁 .14) 夜間模式 (頁 .15)
抽濕模式 (頁 .13)
乾衣模式 (頁 .14)
3. LED 顯示屏 (頁 .13)
當 “%” 燈亮起時，顯示屏會顯示目前大約的濕度；當 “hr” 燈亮起時，會顯示設定運行的時間 (小時)。設定完成後，顯示屏會顯示當前環境濕度 (乾衣、空氣淨化模式除外)，而濕度則會顯示在 35%-80% 範圍。
 注意事項：
若室內相對濕度為80%以上時，顯示為"HI"。
若室內相對濕度為35%以下時，顯示為"LO"。
4. 時間鍵 (頁 .13)
設定所需抽濕時間 (小時)。
5. 濕度鍵 (頁 .13)
設定所需室內的濕度



6. 風速鍵
 切換風速，設有三種不同的風速。
7. 導風板擺動鍵
 切換導風板擺動角度，設三種擺動角度。手動導風板滑動鈕 — 調節左右導風板角度。
8. 負離子鍵
 啟動負離子淨化裝置 (頁 .16)
9. 兒童安全鎖 / 重設鍵 (頁 .16)
 兒童安全鎖燈  亮起，即表示輕觸式控制面已被鎖上。
 重設燈  亮起，即表示過濾網於清潔後需要進行重設。(頁 .20)
10. 提示燈
 "FILTER" (清潔過濾網) — 亮起時提醒用戶需要進行清理過濾網。
 "DEFROST" (自動除霜) — 亮起時代表產品正進行自動除霜，
 目的是防止霜凍從壓縮機內部形成。
 "FULL" (水滿) — 亮起時表示水箱儲水已滿，提醒用戶清空水箱。

安全注意事項

安全標誌

在使用本產品前，請仔細閱讀本使用說明書。使用此產品時，應遵照本說明書的要求，以減少火災、電擊及受傷風險。
請妥善保存此說明書以便日後查閱。



警告

此標誌的內容是必須禁止的行為，否則可能會導致產品警告的損壞及導致死亡或重傷。



注意

此標誌的內容是必須禁止的行為，否則可能會導致受傷及財物損失。



表示不允許做的禁止事項。



警告：此產品只限用於室內使用。此產品不適合及不建議用於家居以外的地方。不適當使用此產品會有機會引致火警，觸電的危險或對人身造成傷害或財產的損失。



表示必須做的強制事項。

警告

有關電源及電線



- 不可使用額定電壓 220V (50Hz) 以外的電源。
- 確保電源線未被擠壓，損壞或過度彎曲。手濕時禁止接觸電源線及插頭。
- 此產品必須連接地線。
- 請確保電源插頭上沒有積塵及沒鬆動後，將其牢固地插入電源插座，及應用乾布擦拭電插頭的灰塵。積塵或接觸不良可導致觸電或火警發生。
- 此產品必須嚴格按照使用地區的接線要求進行。



- 禁止使用容易破損的電源線或插頭。會導致火警或觸電的危險。
- 切勿移除地線的插腳。
- 若電源線損壞，必須由製造商或其維修部之技術人員更換。
- 切勿以拉扯電源線的方式拔出電源插頭。請抓緊插頭，從插座中直接拔出。切勿扭曲或擠壓電源線，防止電源線受損壞。
- 切勿使用拖板或延長線，否則可能會導致火警發生。
- 切勿把產品，插頭或電源線浸泡於水中或用液體噴灑，否則可能會導致觸電或會對人身及財產造成傷害及損失。
- 手濕時切勿接觸電源插頭，斷路器及緊急按鈕。

警告

使用時



- 監顧人必須確保兒童不能將此產品當成玩具使用。
- 確保在移動或不使用此產品前，把水箱內的水倒掉。切勿飲用在水箱內的水。
- 切勿將此產品排出的水給人或寵物作飲用，可能會對身體有害。
- 切勿站立或斜靠在此產品上。否則本機會移動或傾倒而導致受傷。
- 此產品的操作溫度為攝氏 5 至 35 度之間。
- 在維修前，必須把插頭拔出。
- 在移動此產品前，必須將水箱的水倒掉。
- 每次進行產品清潔前，必須將產品完全關掉。產品內置的風扇會以高速運轉，會引致受傷。
- 若長時間不使用此產品，請確保產品拔掉插頭及把水箱內的水倒掉。否則，可能引致短路或發生火警等危險。
- 每次使用後，請把水箱內的水倒掉，以免細菌滋生。



- 切勿將手指或其他物品放置在產品上或放入產品內，否則會有可能會導致受傷。
- 切勿用水或清潔劑直接清洗此產品。
- 此產品不能由無行為能力，或缺乏經驗和知識的人士使用（包括兒童），除非他們已獲得由負責他們安全的人就使用本產品進行監督或指導。
- 此產品只限於室內使用。本機不可直接被陽光照射，或沒有遮蓋的地方使用。否則，有可能導致觸電，短路或火警等危險發生。
- 切勿在產品的出風口處放置燃燒產品，例如火爐。否則可能影響燃燒產品不能正常運作。
- 切勿在衣櫃或家具之間或狹窄不通風的地方使用此產品。若通風不良，可導致本機發熱或火警發生等危險。
- 切勿將裝有水的容器例如花瓶等放置在此產品上或附近，若不慎將水倒入機內，會降低產品的絕緣性能，導致觸電，短路或發生火警等危險。
- 切勿將衣服或任何物產覆蓋在出風口和入風口處。否則通風受阻，可導致本機發熱或火警發生等危險。
- 切勿自行維修，拆卸或改裝此產品。否則，可能引致短路或發生火警。請聯絡生產商或其認可之代理查詢。
- 確保拔掉插頭前，必須將產品完全關掉，否則可能引致受傷。

安全注意事項

注意事項

有關電源及電線



- 切勿使用電線拖板。
- 確保在進行清潔，保養及維修前將電線插頭拔掉。
- 每次使用完此產品後，確保將電線插頭拔掉。
- 當產品發出異味或異聲時，請完全關掉產品，拔掉插頭，並聯絡產品生產商或其認可之代理商。



- 切勿以拉扯電源線的方式拔掉插頭，否則可引致電線損壞及短路等危險。

注意事項

使用時



- 此產品必須保持直立狀態，不可傾斜或翻側。為免產品受損壞，必須將產品放置於平穩的地方
- 請時常確保產品附近有足夠空間（建議空間與產品距離：機頂 50 厘米；機身 20 厘米以上；機背 20 厘米以上，機則 20 厘米以上）
- 當使用連續排水時，確保排水管完全插入排水孔內，避免漏水情況出現，否則可導致產品及週邊物品損壞。
- 當使用連續排水時，確保排水管沒有堵塞及受阻，否則可導致產品損壞。
- 請定期檢查及每兩星期清潔背板(前置濾網 - 納米銀離子濾網)。若通風不良，會影響產品抽濕之能力，及導致結霜，水滴，過熱或火災等危險。
- 若連續長時間使用請定期進行檢查（包括濾網有否堵塞，電源線是否過熱等）
- 當在同一位置，長期使用此產品時，請清除此產品機底部及機身的污垢。請定期移動此產品，及清潔機身底部的地板。

注意事項

使用時

- 請檢查房間尺寸，查看此產品是否有足夠的抽濕能力。當壓縮機變得異常地發熱時，壓縮機會自動停止以防止意外發生。如出現過熱情況，請把插頭從電源拔出，並等待約 45 分鐘後，再次啟動產品。



- 切勿將此產品用於一些需要儲存在常溫保存物品的地方，例如藝術珍品或學術資料等。
- 若沒有裝上生產商指定的濾網，切勿使用此產品。
- 切勿於存有化學物品的地方使用此產品，例如醫院，實驗室，工廠等等，否則可導致燃燒及發生火警等危險。
- 切勿使用易燃清潔劑清洗此產品，例如汽油。詳情請與客戶服務聯絡。
- 當可燃氣體泄漏時，切勿使用此產品，否則可導致燃燒及發生火警等危險。
- 切勿使用輪子將此產品放在不平坦的地面上移動。在不平坦的地面上移動此產品時，請把此產品身抬高，避免損壞滑輪或地板。在厚地毯上移動時，請抬起機身，否則滑輪可能會在地板或地毯上留下痕跡。
- 切勿令機身翻倒或使其掉落。切勿在機身一側儲存物品或用力移動。否則可導致產品損壞或漏水或短路等情況。
- 切勿在高處（如桌子上）使用此產品，否則可導致此產品跌落造成傷害或損壞。
- 切勿觸碰傳感器，如傳感器上有污漬，將無法正常偵測。
- 機身翻倒或運輸後，需直立靜止 4 小時以上，再通電。

注意事項

環境保護



- 包裝物料為 100% 環保，並且有回收標誌。包裝物料不能分散棄置，必須符合所在當地有關法規的規定。
- 有關處理和回收該產品及其包裝更詳細的信息，請聯絡當地有關機構或您所購買本產品的商店作廢物回收。
- 此產品已經取得了回收或可重複使用的材料。報廢必須符合當地的垃圾處理規定進行。報廢前，一定要切斷電源線，使設備無法重新使用。
- 在產品或者產品附帶的文件中有此標誌 ，表示該產品不能被當作一般生活垃圾處理，但必須棄於用作儲存或回收電子 / 電器產品的地方。

包裝卸除

- 卸除所有包裝物料。
- 紙箱，泡沫塑料，塑料袋，標籤必須拆除。



警告

- 包裝物料及塑膠袋可導致窒息，必須讓兒童遠離包裝物料。
- 檢查配件及文件，請根據配件清單檢查所有配件是否齊備，如有任何遺漏，請與門市或客戶服務聯絡。

檢查水箱

- 水箱必須正確安裝，否則將無法開啟。



注意事項：由於出廠前會進行水箱檢驗，可能會有水遺留在水箱，這並不是故障。

使用準備

安裝位置

- 抽濕機必須垂直放置。
- 擺放於一個穩定，平坦地面上。若放置在地毯上，可能會導致翻倒。
- 確保產品附近有足夠空間（建議空間與產品距離：機頂 50 厘米或以上；機身 20 厘米或以上；機背 20 厘米或以上，機側 20 厘米或以上；機側（水箱面）20 厘米或以上）
- 避免光直接照射。
- 若其他電器受到干擾或無法正常顯示時間，請盡可能將抽濕機遠離這些電器。



警告：在下以情況下，切勿使用本產品：

- 存有大量化學物品的地方，例如：工廠、醫院及實驗室
- 存有大量易燃物或氣體品的地方
- 充滿着大量蒸汽或油的地方，如廚房、溫泉等硫化氣體較多的地方

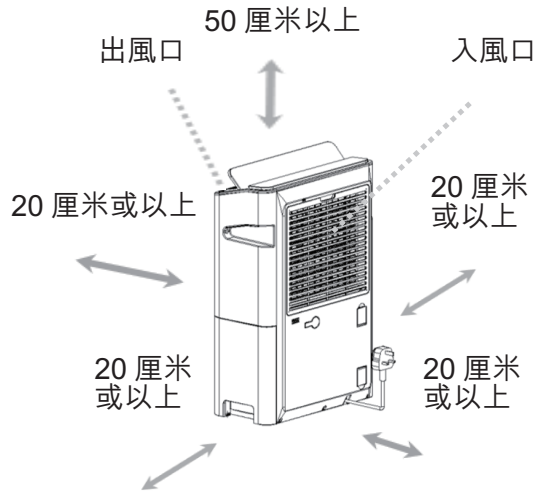

操作條件

- 操作環境溫度 5 °C - 35 °C
- 操作環境濕度 RH% >30%
- 只適合 220V 電源插座
- 將電源插頭插入電源座
 - 抽濕機發出“嗶”一聲，代表已連上電源。
 - 此時控制面板上的 LED 燈未有亮起。
 - 此時除了“開 / 關”鍵及“定時”鍵，其他鍵未能操作。
 - 按“開 / 關”鍵，開啟抽濕機。



警告：以下地方並不適合使用：



- 被陽光直射地方
- 室外戶外地方
- 狹窄的空間環境，如衣櫃內
- 充滿大量蒸汽或油，如廚房





注意事項：

- 若室內相對濕度高於80%時，顯示屏會顯示 "HI"，此時抽濕機如常運作。
- 若室內相對濕度低於35%時，顯示屏會顯示 "LO"，此時抽濕機會出風，而壓縮機會停止運作。

抽濕模式 DEHUMIDIFY

1. 按下“開 / 關”鍵，開啟產品，直至開 / 關燈  亮起。
2. LED 顯示屏  顯示周邊的濕度。
3. 如首次使用，模式會自動依當前濕度自動切換風速及導風板擺動角度為廣角。
4. 如不是首次使用，按下“模式”鍵，直至“抽濕模式”  燈亮起。
5. 按“風速”鍵，以選擇所需的風速。

 最高風速  中度風速  低風速。

6. 按“導風板擺動”鍵，以選擇導風板擺動角度。

 廣角  向上  向前

* 注意 1: 當每次選擇不同的導風板擺動角度時，導風板會先擺到“廣角”最大角度，然後停留約 10 秒才會再次擺動到所選的導風板擺動角度。

注意 2: 當選擇導風板角度後，然後再按一次導風板擺動鍵，導風板會停頓並固定於當前位置。

7. 時間設定

按下“時間”鍵，設定抽濕所需時間，於顯示屏左上角的位置“hr”圖案會閃爍 ，再按下，“時間”鍵或“濕度”鍵選擇運行時間之長短。每按一下“時間”鍵，時間長短會增加 1 小時，由 1 -> 2 -> 3->>11-> 12-> CO (連續)，當時間設定完成後，待 5 秒後確認，顯示屏會切換成顯示當前濕度，當所選的時間已過，此產品會自動停機。

8. 濕度設定

按下“濕度”鍵，設定所需的環境濕度 (RH%)，於顯示屏右上角的位置“%”圖案會閃爍 ，再按下“濕度”鍵或“時間”鍵選擇所需濕度。每按一下“時間”鍵，濕度會增加，由 40% -> 50% -> 60% -> 70% -> 80% -> “--”，而“濕度”鍵則由 80% -> 70% -> 60% -> 50% -> 40% -> “--”。待 5 秒後，顯示屏會顯示當前環境的濕度，當周邊的濕度低於所選的濕度時，此時壓縮機會暫停運作，風扇則會繼續運行。若環境濕度低於 RH30%，產品會自動停機。

9. 按下“開 / 關鍵”關機，此產品會繼續運行，然後停止運作。有關內部乾燥詳細，請參考(頁.21)。





注意事項：

以下情況此產品會停止運作：

- 水箱已滿 (頁 .16)
- 周邊環境溫度及濕度超出操作範圍及設定 (頁 .12)
- 按下 "CO"(連續)，模式連續運作時間超過 48 小時後，自動關機。如在運作途中取出水箱，運作時間會再重新計算。
- 當此產品在關機狀態時，可預設開機時間，如按 01，代表 1 小時後會自動 (開機)。

操作方法

乾衣模式

1. 按下“開 / 關”鍵，開啟產品，直至開 / 關燈  亮起。
 2. 按下“模式”鍵，直至“乾衣模式”燈  亮起。
 3. 在乾衣模式下，顯示屏會顯示 "--"，表示不設定的濕度，而抽濕機會以最高速風速連續運行 3 小時；導風板以廣角擺動。
 4. 按下“導風板擺動”鍵，選擇所需的導風板擺動角度。
🌀 廣角 🌀 向上 🌀 向前
- * 注意 1: 當每次選擇不同的導風板擺動角度時，導風板會先擺到 " 廣角 " 最大角度，然後停留約 10 秒才會再次擺動到所選的導風板擺動角度。
- 注意 2: 當選擇導風板角度後，然後再按一次導風板擺動鍵，導風板會停頓並固定於當前位置。
5. 如有需要，可按“時間”鍵調校運行時間 (1-12 小時) 或 CO(連續)





注意事項：

- 在乾衣模式下，不能設定濕度。
- 在乾衣模式下，可運行負離子淨化裝置功能
- 在乾衣模式下，不能調校風速。

以下情況此產品會停止運作：

- 水箱已滿 (頁 .16)
 - 工作 3 小時後會自動關機
 - 周邊環境溫度及濕度超出操作範圍及設定 (頁 .12)
 - 按下 "CO"(連續)，模式連續運作時間超過 48 小時後，自動關機。
- 如在運作途中取出水箱，運作時間會再重新計算。

第 6 感智能模式

1. 按下“開 / 關”鍵，開啟產品，直至開 / 關燈  亮起。
 2. 按下“模式鍵”，直至“第 6 感智能模式”  燈亮起。
 3. 如果於首次開機，約 5 秒內，風速會設定為低風速。約 5 秒後，依當前濕度，自動調整風速。
 4. 如果不是首次開機，在第 6 感智能模式下，風速會根據以下條件而自動調整：
濕度大於 75% -> 最高風速
濕度介乎 50% 至 70% 之間 -> 中度
風速濕度小於 50% -> 低風速
 5. 按下“導風板擺動”鍵，選擇所需的導風板擺動角度
🌀 廣角 🌀 向上 🌀 向前
- * 注意 1: 當每次選擇不同的導風板擺動角度時，導風板會先擺到 " 廣角 " 最大角度，然後停留約 10 秒才會再次擺動到所選的導風板擺動角度。
- 注意 2: 當選擇導風板角度後，然後再按一次導風板擺動鍵，導風板會停頓並固定於當前位置。
6. 如有需要，可按“時間”鍵，調校運行時間 1-12 小時或 CO(連續)。
 7. 如有需要，可按“濕度”鍵，設定濕度。







注意事項：

在第 6 感智能模式下，不能調節風速。

以下情況此產品會停止運作：

- 水箱已滿 (頁 .16)
 - 周邊環境溫度及濕度超出操作範圍及設定 (頁 .12)
 - 按下 "CO"(連續)，模式連續運作時間超過 48 小時後，自動關機。
- 如在運作途中取出水箱，運作時間會再重新計算。

夜間模式

1. 按下“開/關”鍵，開啟產品，直至開/關燈  亮起。
 2. 按下“模式鍵”，直至“夜間模式”燈  亮起。
 3. 在“夜間模式”下，風速會設定為最低風速。導風板則設定為向上。運行 1 分鐘後，# 空氣質素指示燈便會關上及所有顯示及顯示屏燈會變暗。
 4. 按下“導風板擺動”鍵，選擇所需的導風板擺動角度。
 廣角  向上  向前
- * 注意 1: 當每次選擇不同的導風板擺動角度時，導風板會先擺到“廣角”最大角度，然後停留約 10 秒才會再次擺動到所選的導風板擺動角度。
 注意 2: 當選擇導風板角度後，然後再按一次導風板擺動鍵，導風板會停頓並固定於當前位置。
5. 如有需要，可按“時間”鍵調校運行時間 1-12 小時或 CO(連續)。
 6. 如有需要，可按“濕度”鍵，設定濕度。



注意事項：

在夜間模式下，不能調節風速。

以下情況此產品會停止運作：



- 水箱已滿 (頁 .16)
- 周邊環境溫度及濕度超出操作範圍及設定 (頁 .12)
- 按下 "CO"(連續)，模式連續運作時間超過 48 小時後，自動關機。如在運作途中取出水箱，運作時間會再重新計算。

操作方法

負離子淨化裝置

- 按下“負離子”鍵，直至負離子淨化  燈亮起。
- 此功能能夠獨立運作。
- 建議開啟抽濕模式、乾衣模式、第 6 感智能模式及夜間模式時，同時啟動負離子淨化功能。

兒童安全鎖

1. 按下“兒童安全鎖 / 重設”鍵，5秒內  燈便會亮起，顯示操控面板已被鎖上；電源鍵除外。
2. 按下“兒童安全鎖 / 重設”鍵，5秒內  燈熄滅，顯示操控面板已被解鎖。

排水提示

1. 當“FULL”燈亮起時，表示水箱已滿(約 4.5L)。抽濕機會自動停止運作。

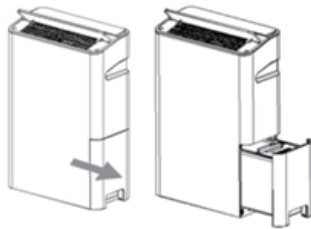

排水口

2. 從產品右側底部取出水箱，而水箱設有把手，能輕易提取水箱。

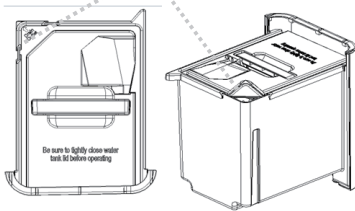

3. 打開排水口和清理積水，直至水箱清空。

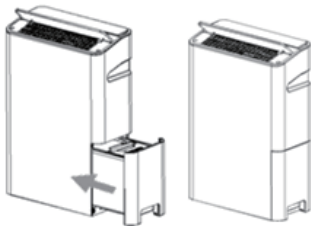

4. 蓋上排水口及將儲水箱放回此產品的原來位置。

5. 當儲水箱放回此產品的原來位置後，提示燈“FULL”便會消除。
 **注意事項：**
當抽濕機運作剛剛結束時，可能還有殘餘的水流到水箱，請避免立即把水箱拉出，以免有餘水流到機殼。

導風板設定

1. 按下“導風板擺動”鍵，選擇直向的導風板擺動角度。
2. 再次按下“導風板擺動”鍵，直至亮燈熄滅，可固定導風板於當前位置。



3. 亦可人手調節左右導風板滑動的角度，以導風板上的按鈕調節左右搖擺的方向。

* 注意：當每次選擇不同的導風板擺動角度時，導風板會先擺到“廣角”最大角度，然後停留約 10 秒，才會再次擺動到所選的導風板擺動角度。

連續排水

1. 關閉此產品及拔下電源插座

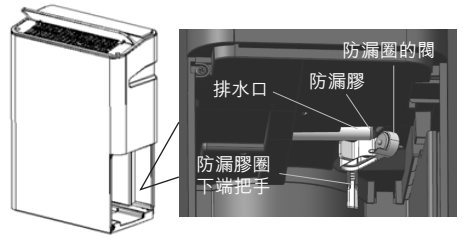
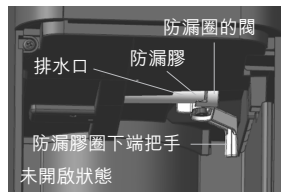
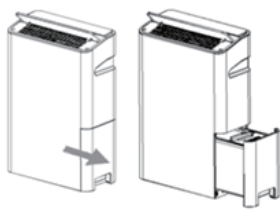

2. 抽出水箱

3. 打開機體內部的排水口

- 用手握住防漏膠圈的下端把手，往左內側推並用力按壓固定位置，打開防漏圈的閥，露出排水口

取消連續排水

- 緊握防漏膠圈的下端部分，向右外側推，讓防漏膠圈返回原位，塞住排水口

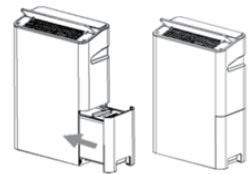
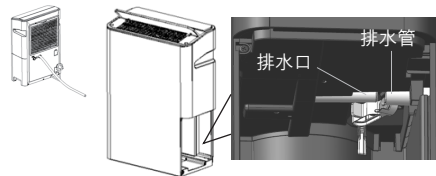
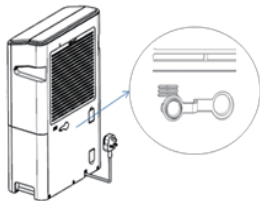

4. 除下排水管背部的排水塞

5. 安裝水管

- 在本體背面排水管出口處放入水管
- 水管放好插在排水口的接駁口

6. 將水箱放入機體
(機體未裝水箱前不能運轉)



注意事項：

- 排水喉內徑 14 毫米（外徑 18 毫米）。
- 確保排水喉緊接配合到排水孔，以避免滲漏。
- 如果水箱放置位置不佳，抽濕模式便不能進行運作。

空氣淨化系統

空氣淨化系統能將空氣進行淨化，同時去除異味，使空氣變得潔淨清新。空氣淨化系統包括 1.) 納米銀離子濾網，2.) 負離子淨化裝置

你可以從以下圖表找到不同型號的空氣淨化系統：

型號	負離子淨化裝置	納米銀離子濾網 (前置濾網)
DS201NB	✓	✓
DS201NT	✓	✓
DS241NB	✓	✓
DS241NT	✓	✓

過濾網

惠而浦抽濕機設有以下不同功能的濾網：

1. 可清洗前置過濾網：主要過濾空氣中的塵埃及毛髮。
2. 可清洗納米銀離子濾網：能有效阻隔空氣中體積較大的粒子及污染物，更有高效抗菌作用，特別是對金黃葡萄球菌及大腸肝菌的抗菌率高達 99%。

過濾網	前置過濾網	前置過濾網 (納米銀離子濾網)
物料	聚乙烯	聚乙烯納米銀離子濾網

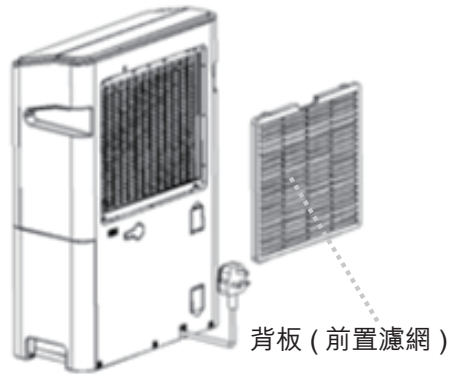

背板 (前置濾網)



前置過濾網(納米銀離子)設於機身後的背板。

負離子淨化裝置

使用高電壓以負離子（電荷）的空氣分子，使空氣中的分子變為正或負電荷。負離子淨化裝置被用來減少空氣中的微塵數量。對於負離子淨化裝置的操作，請參考 16 頁。

保養及維修

清潔前置過濾網

1. 當“FILTER”及“”提示燈亮起時，表示需要清洗前置過濾網。
2. 打開背板，而前置過濾網則貼於背板內方。
3. 用吸塵機輕輕地去除過濾網上的灰塵。
4. 最後，將背板 * 前置過濾網放回此產品上
5. 此時，提示燈“FILTER”及“”提示燈仍然會亮著。長按“LOCK/RESET”鍵直至提示按“”燈完全關掉 (8 秒以上)。



注意事項

- 納米銀離子濾網和前置過濾網是可用水洗的。清洗後從新裝上過濾網，必須徹底吹乾。
- 納米銀離子濾網是過濾網附有納米銀離子塗層，顏色為銀色。如果經常清洗，顏色可能會有所改變 (如黑色或灰色)。

除霜功能

1. 當銅管溫度感應器感應到蒸發器表面溫度小於或等於 0 度時，抽濕機會啟動自動除霜功能。
2. 當“DEFROST”燈亮起，此產品會啟動除霜功能 (除壓縮機會執行 24 分鐘，然後 8 分鐘內停止。其他負載工作狀態無變化。)，此循環會不停重覆直到在機內凝結的霜完全清除。
3. 若在 24 分鐘壓縮機需啟動的時間內，如銅管溫度持續小於 0 度，壓縮機便不會啟動。

內部乾燥

1. 關機後，風扇會於高風速連續運行約 10 秒，把機內水份吹乾，以防止霉菌滋生。此時 "Defrost" 會亮起紅燈，已表示機內正進行水份吹乾。

背板 (前置濾網)

1. 除了納米銀離子過濾網外，灰塵亦可能被困於背板內。建議每兩周清潔背板一次。
2. 打開背板，用吸塵機輕輕地去除背板上多餘的灰塵。

水箱

1. 每次使用此產品後，必須清空水箱內的剩餘的水份。

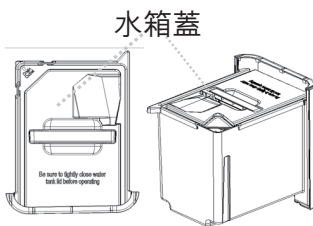

2. 除去水箱蓋板，用軟抹布擦乾水箱。



3. 將水箱蓋放回水箱及放回產品原本的位置。

主機

建議定期清潔此產品的機身。

1. 清潔前，必須拔掉電源插頭。
2. 使用濕的軟布或中性洗滌劑擦進行清潔，再用乾布抹乾。
3. 若長時間不使用此產品，建議拔掉電源插頭，清潔，包裝此產品及存放於乾燥及沒有陽光直接照射的地方。



警告

- 切勿使用沸水，去污劑，酸性或鹼性洗潔劑，肥皂，研磨粉，汽油，稀釋劑，酒精，苯有機溶液和刷子清潔抽濕機。
- 切勿用噴水沖洗方式去清洗抽濕機。

故障事項

在聯絡客戶服務部前，請先檢查是否出現以下情況，從而找出解決方案。若問題仍未能解決，請勿自行拆開機殼及進行維修。應立即停止使用此產品，與客戶服務聯絡。

問題	疑難排除
抽濕機產生熱風	<ul style="list-style-type: none">當使用第 6 感智能、夜間、抽濕及乾衣模式時，會產生熱風，是正常現象，並不是故障。
抽濕機不能正常運作	<ul style="list-style-type: none">檢查電源是否連接；電壓是否過低；電源插頭是否插牢。檢查環境溫度是否處於 5 °C 至 35 °C 之間。因為此產品的運作溫度是設定於 5 °C 至 35 °C 之間。檢查周邊環境濕度是否大於 30%。因為此產品操作環境濕度必須大於 30%。檢查是否已裝上水箱。若沒有裝上水箱，此產品將無法正常工作檢查水箱是否放置在適當的位置(頁 .16) 檢查水箱是否已滿。若是，請清空水箱(頁 .12) 檢查空氣入口和出口是否被堵塞。若是，請除去障礙，並確保有抽濕機有足夠的空間使用。
抽濕機沒有效能 (濕度水平沒有下降 至設定水平)	<ul style="list-style-type: none">檢查背板，是否正確關上。檢查是否有電器或設備產生蒸汽檢查房間面積是否過大檢查抽濕功能是否正在開啟(頁 .20) 檢查是否需要清潔過濾網。

問題	疑難排除
<p>產品發出噪音</p>	<ul style="list-style-type: none"> • 聲音是由於抽濕機於高風速運行所產生，音量會因環境而有所變化，此產品性能是不受影響的。 • 壓縮機運行時亦會產生聲音，屬正常現象，這不是故障。 • 聲音的音量是取決於導風板的角度。 • 檢查此產品是否放置在平面上。 • 檢查背板是否正確地裝上。 • (頁 .12) 檢查空氣入口和出口是否被堵塞。若是，請除去障礙，並確保有此產品有足夠的空間使用。 • (頁 . 20) 檢查是否需要清洗過濾網。
<p>漏水情況</p>	<ul style="list-style-type: none"> • 檢查水箱是否放置在平面上。 • 檢查此產品是否處於在水平的表面上。 • 在連續排水的情況下，檢查排水管是否正確地插入排水孔。 • 是否水箱剛剛拉出清空，引致機內殘餘的水流到機殼。
<p>濕度計顯示濕度與產品不符</p>	<ul style="list-style-type: none"> • 抽濕機顯示的濕度為現行位置的濕度，可能與其他位置的濕度不同。 • 抽濕機所顯示的濕度是存在正常誤差，並不能與濕度計直接作比較。
<p>電源線或插頭產生過熱</p>	<ul style="list-style-type: none"> • 嘗試將插頭改插另一個插蘇座，看是否有同樣情況。 • 停止使用此產品，並立即聯繫客戶服務尋求協助。

規格表

產品型號	DS201NB DS201NT	DS241NB DS241NT
電源	220V 50Hz	220V 50Hz
容量 (升 / 日) (溫度 : 26.7 °C ; RH 60%)	12 升	14 升
容量 (升 / 日) (溫度 : 30 °C ; RH 80%)	20 升	24 升
耗電量 (kWh / 每日)	6	6.60
淨重	13	13.3
尺寸 (L x H x W) 毫米	380 x 570 x 175	380 x 570 x 175
把手	隱藏式把手	隱藏式把手
排水	連續排水 / 可外接 排水管連續除濕	連續排水 / 可外接 排水管連續除濕
水箱容量 (升)	5升	5升
水滿防溢容量 (升)	4.5 升	4.5 升
雪種	R134a (160 克)	R134a (220 克)

因產品改進和技術更新，參數更新後，恕不另行通知，請以抽濕機的規格標籤為準。

Dear User,

Thank you for choosing our products. We are sure you will find your new appliance please to use. Before using this appliance, we highly recommend you read through this operation instruction carefully and retain for future reference. Design and specification may change due to product development, no prior notice will be given.

Content

Product Overview	Product Features	27
	Diagram(Front view)	28
	Diagram(back view)	29
	Control panel	30-31

Safety Instruction	Safety labels	32-33
	Safety notice	34-36

Before Use	Unpacking	37
	Check water tank	37
	Positioning	38
	Operation Condition	38

Using Your Dehumidifier	Dehumidifying	39
	Laundry.....	40
	6th sense	40
	Night	41
	Ionizer	42
	Child Lock	42
	Drainage	42
	Louver Setting	43
	Continuous Drainage	43





Air Purifying System	Filter	44
	Ionizer.....	45

Care and Maintenance		46-47
----------------------	--	-------

Troubleshooting		48-49
-----------------	--	-------

Product Specification		50
-----------------------	--	----

Product Features

	6th Sense mode – Whirlpool’s 6th Sense Control System detects the ambient humidity changes through it’s intelligent humidity sensors, and reacts to make a prompt adjustments on the Fan speed.
	Dehumidifying mode – Fan Speed and operation hours can be adjusted by personal setting.
	Laundry mode – Dry the clothes with maximum fan speed. Not only suitable in humidity season but the entire year.
	Night mode – Motor and fan speed will operate in extra low speed, ultimately leads to silent and comfortable of air purification.

Product Overview

Diagram (Front View)

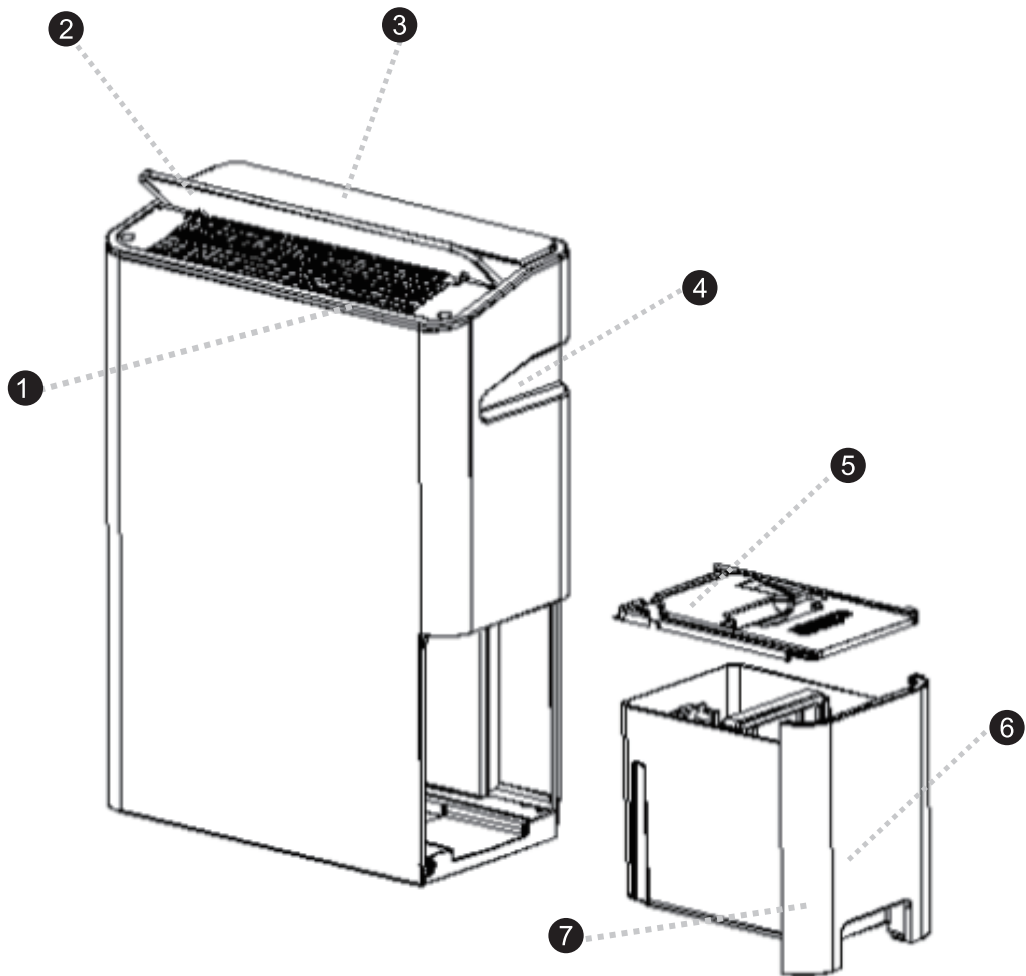

- 1. Horizontal louver slide
- 2. Louver
- 3. Control panel
- 4. Side hidden handle

- 5. Water tank lid
- 6. Water tank
- 7. Water mark

Diagram (Back View)

Models: DS201NB/DS201NT/DS241NB/DS241NT

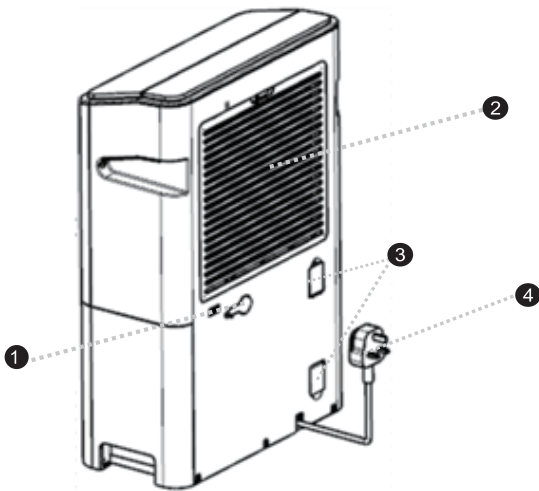

1. Outlet of continuous drainage
2. Rear panel (*Pre-filter)
3. Power cable stand
4. Power plug

* 20L and 24L: Rear panel(Nano Silver Ion Pre-filter)

Product Overview

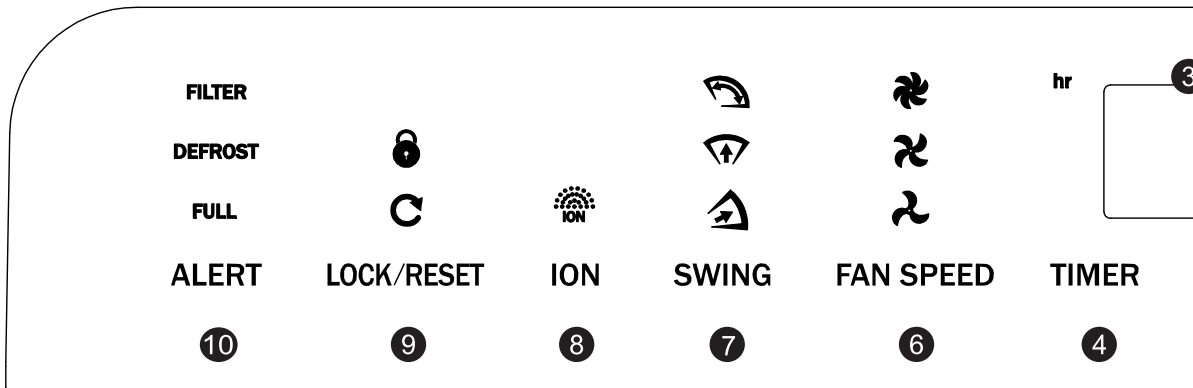

1. Power key
On/Off the unit

2. MODE
Select 6 different operation mode includes

- 6th Sense (P.40)
- Dehumidifying (P.39)
- Laundry (P.40)
- Night (P.41)

3. LED Display (P.39)

When “%” lights, Indicates the approximate humidity; When “hr” lights, indicates the Timer. After setting, LED Display will show the current humidity (except Laundry and Air Purify mode). The displayed range of humidity is from 35% - 80%



Remarks:

When the room relative humidity is higher than 80% , "HI" will be displayed.

When the room relative humidity is lower than 35% , "LO" will be displayed.

4. Timer Key (P.39)
Set the duration for humidity mode.

5. Humidity Key (P.39)
Set your desire humidity

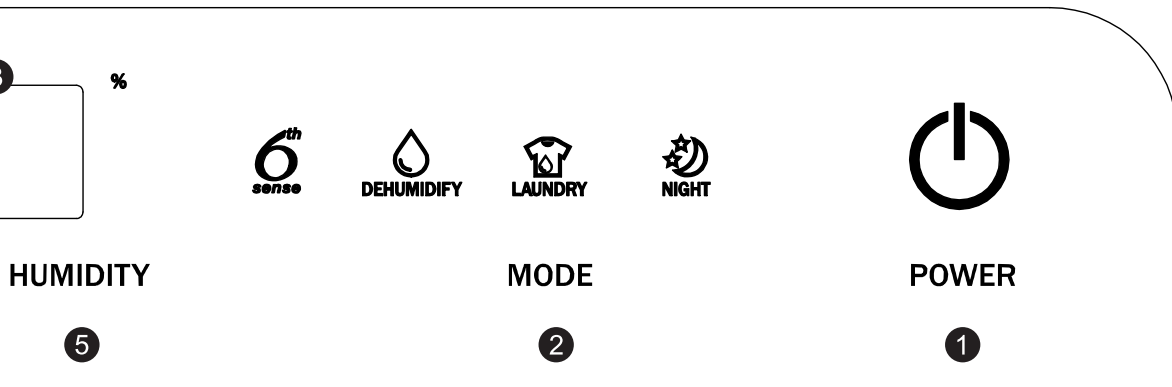

6. Fan Speed Key

There are 3 fan speed for selection



7. Louver Swing Key

There are 3 Vertical swing direction of louver for selection.

8. Ion Key (P.42)

Turn on ionizer function

9. Lock/Reset Key (P.42)

- Child lock  is activated when the light is on.
- After cleaning the filter, reset is necessary when the reset  light is on. (P.46)

10. Alert

"FILTER" - When lights, it is necessary for user to clean the filter.

"DEFORST" - When lights, the unit starts defrosting automatically in order to prevent frost from forming inside the main unit.

"FULL" - When lights, it means the water tank is full, it is necessary for user to empty the tank.

Safety Instructions

Safety label

Please read all instructions carefully before using this product. When using the appliances, should always follow this instruction to reduce the risk of fire, electric shock, and injury to person.

Please keep this manual. If you deliver the appliance to other users, do handover this manual together.



WARNING

This mark indicates the behaviors is strictly prohibited, which may result in fatal or serious injuries



CAUTION

This mark indicates the behaviors is strictly prohibited, which may result in injuries or damage to product or property



Prohibit Action



Warning: This appliance is intended for use in domestic environment only. Any other use is not recommended. Improper user may cause fire, electric shock or other injury to person or property.



Mandatory Action



WARNING

Power and Power Cord



- Make sure the voltage is 220V(50Hz). This appliance is only operated at the rated voltage.
- Make sure the power cord is not squashed, damaged or overly bended, and do not touch the power cord and plug/unplug with wet hands.
- This product must be connected to the ground wire.
- Make sure no dust on the power plug and insert into the outlet firmly. Wipe off the dust by dry cloth periodically. Dust will accumulate on the power plug if it is not insert into the outlet firmly. It may cause electric shock or fire.
- The appliance shall be installed in accordance with national wiring regulations.



- Do not use easily-damaged power cord or plug. It may cause fire or electric shock.
- Do not remove earth pin.
- If the supply cord is damaged, it must be replaced by a special cord or assembly available from the manufacturer or its service agent.
- Do not pull the power supply cord to remove it from the socket. Do not twist or press the power supply cord, and make sure it is not broken.
- Do not use extension cord, otherwise it may cause fire hazard.
- Do not immerse unit, plug or power cord in water or spray with liquid; it may cause electric shock or other injury to product.
- Do not touch the power plug, circuit breaker and emergency button when your hands are wet.

WARNING

During Usage



- Children should be supervised to ensure that they do not play with the appliance.
- Always empty the water tank before move and unused.
- Do not drink the accumulated water. Do not use the drain water for humans or pets to drink. It may be harmful to health.
- Do not stand on or lean against the unit. This may cause it to fall over, resulting in personal injury.
- The ambient operation temperature of this unit is between 5°C-35°C.
- Unplug before serving
- Ensure water tank is empty before moving the unit.
- Always switch off the unit before cleaning. The internal fan rotate in high speed may cause injury.
- If not using the unit for long time, ensure it is safely unplugged and empty water tank. Otherwise electric shock or fire may result.
- Empty and clean the water tank frequently to prevent bacteria growth.



- Do not put your finger or anything on top of the unit or inside the unit. It may result in injury.
- Do not wash the unit directly with water or cleansing detergent.
- This appliance is not intended for use by person (including children) with reduced physical, sensory or mental capabilities or lack of experience and knowledge, unless they have been given supervision or instruction concerning user of the appliance by a person responsible for their safety.
- The units for indoor use only. Do not use in locations without shelter or exposed to direct sunlight. This may cause overheating, electric shock, short circuit or fire.
- Do not place in the vicinity of a burner such as a stove. This may prevent proper heating
- Do not operate in a cupboard or in any narrow or confined space. Insufficient ventilation may cause overheating or fire.
- Do not place any water container such as a vase on the unit. Water spillage may impair insulation and cause electric shock, short circuit or fire.
- Do not obstruct air intake or outlet with clothing or anything else. Obstruction of the airflow causes overheating, malfunction or fire.
- Do not attempt to repair, dismantle or modify the unit. This may cause electric shock or fire. Please contact Whirlpool customer service centre.
- Do not unplug the power cord without power “OFF” the appliance as it could injury the unit.

Safety

Instructions

CAUTION

Power and Power Cord



- Do not use extension cord
- Disconnect power plug before cleaning, maintenance and servicing.
- Disconnect power plug from power supply when the appliance is not in use for a long period of time .
- Disconnect power plug when there is strange smell or abnormal noise from the appliance, and then contact service agency.



- Do not pull out the power plug by pulling the power cord, it may cause the power cord damage and electric shock.

CAUTION

During Usage



- This unit should always keep in an upright position. To avoid damage, this unit should be located on a flat and stable surface.
- Always have plenty of room around the main unit(Recommended space: Upper 50cm; Side 20 cm or more on each side; Behind 20cm or more; Front; 20cm or more)
- When using the continuous drainage, make sure the pipe insert to the hole completely to prevent water leakage to surrounding. It may cause damage to other object and the unit.
- When using continuous drainage, make sure there is no obstruction on the pipe. It may damage the unit.
- Check and clean the nano-silver pre-filter every two weeks. Insufficient ventilation may cause low dehumidification performance, frosting, dripping, overheating or fire.
- Regularly inspect any unit used continuously or for long periods (filter block, power cord overheat). Otherwise overheating or short circuit may result.
- If the unit is operated in the same position for some time, you should check for dirt under and around it. Move the unit intermittently and clean the floor under it.

CAUTION

During Usage



- Check that the room where the unit is to operate is not too small. When its compressor overheats, it cuts out automatically to prevent accidents. Should this happen, unplug the appliance, rectify the problem, wait for about 45 minutes and then restart the unit.



- Do not use the unit to control ambient temperature for storage – for instance for artworks or books, Doing this may cause deterioration of the objects.
- Do not use the unit without air filter.
- Do not use the unit in place where chemicals are used such as hospitals, laboratories, factories etc...It may cause combustion and fire.
- Do not use flammable detergent to clean the appliance, such as gasoline, and then contact service agency.
- Do not use the unit in place where flammable gas or oil is leakage. It may cause combustion and fire.
- Do not move the unit on its castors on an uneven surface. Lifting the unit instead prevents damage to castors and floor. This advice also applies to thick-pile carpets, because the castors may leave marks.
- Do not topple or drop the unit or ever put it on its side. This might damage it or cause a leak or short circuit.
- Do not use unit the unit above floor level, for instance on a table. This might cause the unit to fall, resulting in personal injury or damage to the unit
- Do not touch the sensor lens. The sensor cannot work well if the lens is stained.
- When the machine was turned over or after transportation. It need to be stand still for more than 4 hours. Then, it can be power on.

Safety

Instructions

CAUTION

Safeguarding the Environment



- The packaging can be 100% recycled as confirmed by the recycling symbol. The various parts of the packaging must not be dispersed in the environment, but must be scrapped in line with local authority regulations.
- For more detail information on handling and recycling of this product and its' packaging, contact your local authorities who deal with the separate collection of rubbish or the shop where you bought the appliance.
- This appliance has been made of recyclable or re-usable material. Scrapping must be carried out in compliance with local waste disposal regulations. Before scrapping it, make sure to cut off the mains cord so that the appliance cannot be re-used.
- The symbol on the product or on the documents accompanying the product indicates that this appliance should not be treated as household waste , but must be given to the appropriate local gathering place where electric and electronic appliances are stored and recycled.

Unpacking

- Unpack all the packaging materials.
- Carton box, foams, plastic bag, stickers must be removed.



WARNING

- Keep children away from the packaging since the folded packing and plastic bag may cause suffocation.
- Check all accessories and documents. Please check the accessories inside the package according to packing list, contact the shop from which you purchased if anything is missing.

Check Water Tank

- Water Tank must be properly installed otherwise it will not start.



CAUTION: There may be some water left in the water tank from the product inspection in factory. This is not a malfunction.

Before Use

Positioning

- Place the unit in an upright position
- On a stable and flat surface. Carpet or futon is an unstable place. Do not place above floor level such as on table.
- Enough space around the unit. (Recommended space: Upper 50cm or more; Side 20 cm or more; Water tank side 20cm or more; Behind 20cm or more; Front; 20cm or more)
- Avoid place in direct sunlight
- Any electric machine in the same space, if there is noise or cannot display correct time, move the product far as far as possible.



CAUTION: Do not use the product in below area

- With a lot of chemicals are used such as factory, hospital, laboratories
- With a lot of flammable gas or oil
- With a lot of steam or oil such as kitchen
- With a lot of sulfide gas such as hot-spring are

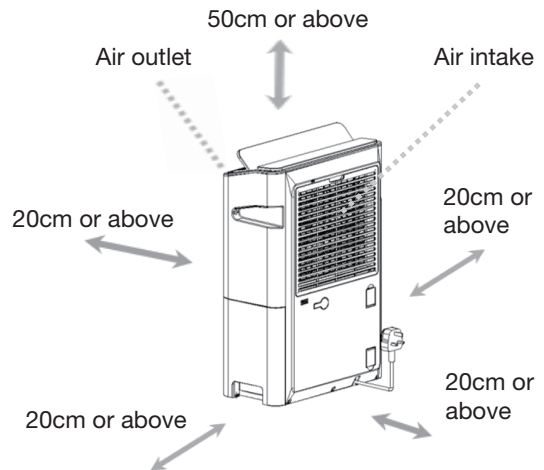

Operation Condition

- Operation ambient temperature 5°C - 35°C
- Operation ambient humidity RH% >30%
- 220V AC power supply only
- Plugging Power plug into power socket

- "Beep" sounds indicate connect to power source
- At this moment, no icon light up in the control panel.
- All keys are no response, except "POWER" key and Timer Key.
- Press "POWER" to start the machine



WARNING: Do not use in the following places









- Directly sunshine
- Outdoor
- Narrow space environment such as inside cabinet
- With a lot of steam or oil such as kitchen



CAUTION:

- Display shows "HI", when the room relative humidity is higher than 80%, at this moment, dehumidifier operates as normal.
- Display shows "LO" when the room relative humidity is lower than 35%, at this moment, compressor will stop operation.

DEHUMIDIFY

1. Press "POWER" key to turn on the dehumidifier,  lights up
 2. LED displays the ambient humidity
 3. In the first time, the mode will base on current humidity to change the fan speed automatically. And set the swing angel as the largest one
 4. If it is not the first time, press "MODE" key until  lights up.
 5. Press "FAN SPEED" key to select fan speed
 High fan speed  Medium fan speed  Low fan speed
 6. Press "SWING" key to select vertical louver swing angle
 Air Flow  Front-up  Front-down
- Remarks 1 : When choosing different angle of the louver, louver will be swing to the largest angle for 10 seconds first, and then move to the selected option.
- Remarks 2: Press the Air flow icon again, louver will stop as is.
7. Timer setting
 Press "TIMER" to set the dehumidifying duration. The "hr" on the top left corner of display will flash , Press the "TIMER" or "HUMIDITY" key to select the duration with sequence 1 -> 2 -> 3->>11-> 12-->CO(CONTINUOUS). The dehumidifier will stop when time is up.
 8. Humidity setting
 Press "HUMIDITY" to set the desire ambient humidity(RH%). The "%" on the top right corner of display will flash , the desire RH% by pressing the "HUMIDITY" or "TIMER" key to select the humidity. "TIMER" increases the RH% with sequence 40% -> 50% -> 60% -> 70% -> 80% -> CO (continuous) and "HUMIDITY" in decreasing sequence 80% -> 70% -> 60% -> 50% -> 40% -> CO (continuous), 5 seconds later, display will show the current ambient humidity. When the ambient humidity is lower than selected humidity. The display will show the current ambient humidity. At that moment, the compressor will stop operation. But the fan will keep operate. The machine will stop automatically when the ambient humidity is lower than 30%.
 9. Press "POWER" to stop the machine, Machine will continuous to operate for 10 seconds Then, it will stop operation. (For details of 'INTERNAL DRY", please refer to P.47)





CAUTION

Remark: Machine will stop under following situation:

- when the water tank is full (P.42)
- when the temperature or humidity is out of operation range (P.38)
- Press "CO"(continuous), the unit will stop automatically after 48 hours operation. If water tank was taken out during operation , the counting time will start over again.
- When the unit is off, the user can pre-set the operation time. For example, press 01, that's mean it will turn on automatically after 1 hour.

Using your Dehumidifier

LAUNDRY LAUNDRY





1. Press "POWER" key to turn on the dehumidifier,  lights up
 2. Press "MODE" key until  lights up.
 3. Under laundry mode, the LED Display will show "--" and cannot set the humidity. Under this mode, the fan speed operates at high speed, auto swing and will stop automatically after 3 hours operation.
 4. Press "SWING" key to select vertical louver swing angle
 Air flow  front-up  front-down
- Remarks 1 : When choosing different angle of the louver, louver will be swing to the largest angle for 10 seconds first, and then move to the selected option.
- Remarks 2 : Press the Air flow icon again, louver will stop as is.
5. If necessary, press "TIMER" key to adjust the operation duration 1-12 hours or CO (continuous).



Remark:

- Under laundry mode, humidity and timer cannot be set.
 - Under laundry mode "ION" function can be turned on.
 - Under laundry mode, FAN SPEED cannot be adjusted.
- Machine will stop under following situation:
- when the water tank is full (P.42)
 - after operation for 3 hours
 - when the temperature or humidity is out of operation range (P.38)
 - Press "CO"(continuous), the unit will stop automatically after 48 hours operation. If water tank was taken out during operation , the counting time will start over again.

6th Sense







1. Press "POWER" key to turn on the dehumidifier,  lights up
 2. Press "MODE" key until  lights up.
 3. In the first time, the fan speed will set as Low Fan Speed within 5 seconds, after that, it will base on current humidity to adjust the fan speed automatically.
 4. Under 6th Sense mode, the fan speed will change automatically according to following condition:
 - RH% > 75% : High Fan Speed
 - RH% 50%-70% : Medium Fan Speed
 - RH% < 50% : Low Fan speed
 5. Press "SWING" key to select vertical louver swing angle
 Air flow  front-up  front-down
- Remarks 1 : When choosing different angle of the louver, louver will be swing to the largest angle for 10 seconds first, and then move to the selected option.
- Remarks 2 : Press the Air flow icon again, louver will stop as is.
6. If necessary, press "TIMER" key to adjust the operation duration 1-12 hours or CO(continuous).
 7. If necessary, press "Humidity" key to adjust the humidity level.



Remark:

- Under 6th Sense mode, fan speed cannot be adjusted.
- Machine will stop under following situation:
- when the water tank is full (P.42)
 - when the temperature or humidity is out of operation range (P.38)
 - Press "CO" (continuous), the unit will stop automatically after 48 hours operation. If water tank was taken out during operation , the counting time will start over again.

Night

1. Press “POWER” key to turn on the dehumidifier,  lights up
 2. Press “MODE” key until  lights up.
 3. Under Night mode, fan speed operates at extra low speed. Louver will set at front-up. After 1 minute operation, the Air Quality  LED* will turn off and the display & other icon will become dim.
 4. Press “SWING” key to select vertical louver swing angle.
 Air flow  front-up  front-down
- Remarks 1 : When choosing different angle of the louver, louver will be swing to the largest angle for 10 seconds first, and then move to the selected option.
- Remarks 2 : Press the Air flow icon again, louver will stop as is.
5. If necessary, press “TIMER” key to adjust the operation duration 1-12 hours or CO(continuous).
 6. If necessary, press “Humidity” key to adjust the humidity level.



CAUTION

Remark:

- Under Night mode, the fan speed cannot be adjusted

Machine will stop under following situation:



- when the water tank is full (P.42)
- when the temperature or humidity is out of operation range (P.38)
- Press "CO" (continuous) the unit will stop automatically after 48 hours operation. If water tank was taken out during operation , the counting time will start over again.

Using your Dehumidifier

IONIZER

- Press “ION” key until  lights up.
- This function can be operated independently.
- It is suggested to turn on the ionizer together under LAUNDRY, DEHUMIDIFY, 6th SENSE and NIGHT mode.

CHILD LOCK

1. Press “LOCK/RESET” key for above 5 seconds,  lights up to activate the key lock function, but the POWER Key is still functional.
2. Press “LOCK/RESET” key for above 5 seconds until  disappear, to deactivate the key lock function.

DRAINAGE

1. When the “ **FULL** ” indicator lights up, it means the water tank is full (around 4.5L) , The unit will be stopped automatically.



Drain outlet

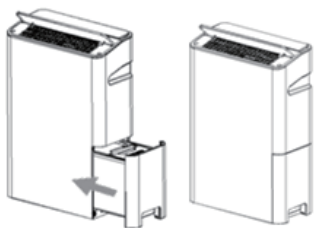
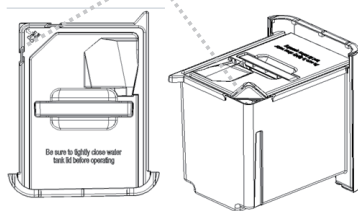

2. Take out the water tank gently. There is a handle at the bottom of water tank.

3. Open the drain outlet and empty the water tank.

4. Close the drain outlet and place the water tank back to the unit.

5. The “ **FULL** ” indicator will disappear when the empty water tank return to its position.



Remarks:

To avoid residual water from leaking into the machine , water tank should not be pulled out immediately once the operation is completed.

Louver Setting

1. Press "SWING" key to select the vertical louver swing angle.
2. Press "SWING" until the light is off, the louver will stop at the angle as is.



Vertical louver swing in wide angle



Vertical louver swing forward angle



Vertical louver swing forwards

3. For horizontal louver, it can be operated manually by adjusting the horizontal louver slide to left or right.

Remarks: When choosing different angle of the louver, louver will be swing to the largest angle for 10 seconds first, and then move to the selected option.

CONTINUOUS DRAINAGE

1. Power off the unit and unplug the power plug

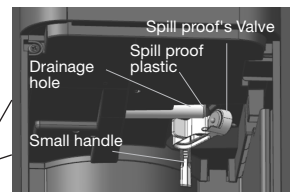
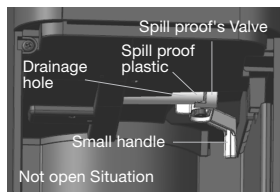
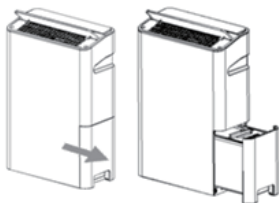

2. Take out the water tank

3. Open the drainage hole

hold the small handle (lower part of valve) and move toward left hand side. Then push the small handle and fix the position. The valve will be opened.

Cancel continuous drainage

return the valve to original position, by pull the small handle towards to your side.

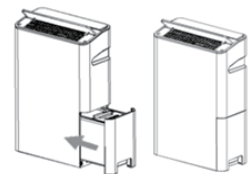
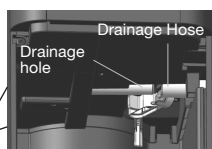
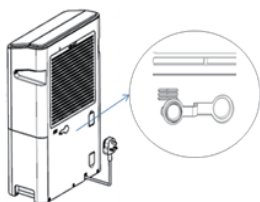

4. Take off the stopper on the backside

5. Insert the drainage hose

- inside the machine through the stopper hold.
- The drainage hose should be connected to the drainage hole.

6. Replace the water tank

CAUTION

Remark:

- Drain hose inner diameter 14mm (outer diameter 18mm)
- Ensure tight fit of the drain hose to the drainage hole to avoid water leakage.
- If water tank is not in proper position, dehumidifying operation cannot be performed.

Air Purifying System

Air purifying system is used to remove contaminants and odors in the air. Our dehumidifier also include air purify system as follows:

1. Nano Silver ion filter
2. Ionizer

You can find the air purifying system in different models as follows:

Model	Ionizer	Nano silver ion coating pre-filter
DS201NB	✓	✓
DS201NT	✓	✓
DS241NB	✓	✓
DS241NT	✓	✓

1. Filter

The filters in Whirlpool’s dehumidifier with different functions:

1. Washable Pre-filter: Use to filter dust and hair in the air.
2. Washable Nano Silver Coating Pre-filter: Use to filter dust in the air and effective on anti-bacterial activities, especially for MRSA and E. coli with nearly 99% efficiency.

Filter	Pre-Filter	Nano Silver ion Coating Pre-filter
Materials	polyethylene	Polyethylene with Nano Silver ion coating Prefilter

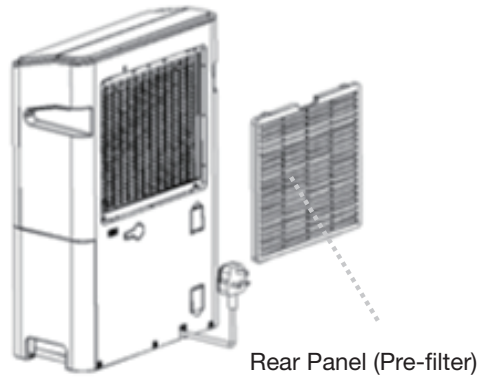

The pre-filter (Nano Silver) is under the cover at rear panel.

2. Ionizer

Uses high voltage to ionize (electric charge) air molecules, such that the air molecules becomes positive or negative charges. Ionizer is used to remove particles in the air. For Ionizer operation, please refer to P.42.

Care and Maintenance

Clean the pre-filter

1. When “ **FILTER** ” & “ **C** ” light up, it is necessary to clean the pre-filter.
2. Take off the Filter Cover at back of dehumidifier and pre-filter is stick inside the Filter Cover.
3. Remove the dust on filter by vacuum them gently.
4. Return the pre-filter to the Filter cover to the machine.
5. At this moment, the “ **FILTER** ” & “ **C** ” still light up, press the “ **LOCK/RESET** ” key for more than 8 seconds until both “ **FILTER** ” & “ **C** ” disappear.

CAUTION

Remark:

- Nano-Silver Ion coating pre-filter and Pre-filter (rear panel) are washable. Make sure to dry them completely before replace to dehumidifier.
- Nano-Silver Ion coating pre-filter is a pre-filter with nano silver coating, which is in silver color. It may change color (such as black or gray) if wash frequently.

Defrost

1. When the copper pipe temperature sensor to the evaporator surface temperature is less than or equal to 0°C, the auto Defrost function will be activated automatically.
2. The “ **DEFROST** ” indicator will light up and dehumidifier will start defrost cycle (the compressor will perform 24 minutes ON, 8 minutes OFF, no other loading conditions change.), the cycle will repeat until frost free in dehumidifier.
3. When the compressor is running within 24 minutes, but the temperature of the copper pipe keep below to 0°C, the compressor will not function.

1. Internal Drying

1. When POWER OFF, the Fan will continue to operate for 10 seconds at high fan speed to dry out the internal moisture for anti-mildew purpose. At this moment, the light "DEFORST" will light up. That's mean the internal drying function is in progress.

2. Rear Panel (Pre-filter)

Except the filter, heavy dust may also trapped around the rear panel. It is suggested to clean the rear panel bi-weekly.

1. Take off the filter cover and vacuum the rear panel gently to remove heavy dust.

3. Water Tank

1. After each use of dehumidifier, empty the water tank.



2. Remove the water tank lid and dry the water tank by using a soft cloth



3. Return the water tank lid and place the water tank back to the machine.

4. Main Body

It is recommended to clean the main body of dehumidifier regularly.

1. Unplug the power plug before cleaning.
2. Use wet soft cloth or mild detergent to wipe the dehumidifier and followed by a dry cloth.
3. If the dehumidifier will not be used for a long time, it is recommended to unplug, clean and wrap the machine and store in a dry place without sunlight.



CAUTION

- Boiling water, eradicator, acid or alkaline detergent, soap, abrasive powder, gasoline, thinner, alcohol, benzene organic solution and brush are not allowed to use for cleaning
- Do not rinse clean with water spray

Trouble shooting

Please check the below phenomenon to find out the solution before contact customer services department. If the problem still cannot be solved, please do not dismantle the machine. You should stop using the dehumidifier and contact customer services to solve the problem.

Problem	Possible Cause & Solution
Dehumidifier generate warm air	<ul style="list-style-type: none"> • Warm air will be generated during 6th sense, dehumidifying and laundry function. It is not a malfunction
Dehumidifier is not working	<ul style="list-style-type: none"> • Check the power is connected; voltage is too low; power plug is plugged firmly. • Check the ambient temperature is between 5°C ~ 35°C. As the operation temperature of the dehumidifier is 5°C ~ 35°C. • Check the ambient humidity RH% >30%. As the operation humidity of the dehumidifier is RH% >30%. • Check the water tank is placed. Without water tank lid, the dehumidifier will not work. [P.43] • Check the water tank is placed in proper position. • (Check the water tank is full or not. If yes, dispose the water. [P.42]) • Check if the dehumidifier is under defrost process • Check if the air inlet and outlet is blocked. If yes, remove the barrier and make sure there is enough space for the dehumidifier [P.38]
Dehumidifier is not efficiency (Humidity level does not drop to set level)	<ul style="list-style-type: none"> • Check the door and windows are closed or not. • Check if there is any appliance producing steam in the room. • Check if the room size is too big. • Check if dehumidifying function is turn on • Check if the filter is dirty. Clean the filter [P.46]

Problem	Possible Cause & Solution
<p>The dehumidifier is noisy</p>	<ul style="list-style-type: none"> • The sound is generated due to the air flow especially in HIGH fan speed. The sound level varied with the environment but the efficiency is not affected. • Sound will be generated when starts up. It is due to the operation of compressor. It is not a malfunction. • The volume of sound is differs depending on the louver angle. • Check if the dehumidifier is placed on a flat surface. • Check if the rear panel is in proper position • Check if the air inlet and outlet is blocked. If yes, remove the barrier and make sure there is enough space for the dehumidifier [P.38] • Check if the filter is dirty. Clean the filter [P.46]
<p>Water leakage</p>	<ul style="list-style-type: none"> • Check if the water tank is in proper position. Check if the dehumidifier place in a flat surface. • If under continuous drainage, check the hose inserted in the drainage hole properly. • Whether the water tank pull out the water empty, causing the machine having the remaining water inside the machine.
<p>The humidity shows on display is different from hygrometer</p>	<ul style="list-style-type: none"> • The display shows the humidity level at its current position , which may be different from the level at other position. • The humidity level shows by the product contains tolerance , which is normal. And it should not be compared with the hygrometer directly.
<p>Power Cord or plug generate abnormal heat</p>	<ul style="list-style-type: none"> • Try the plug into another plug socket to see whether still have the same situation or not. • Stop using the dehumidifier immediate and contact customer services for help.

Specification

Model	DS201NB DS201NT	DS241NB DS241NT
Power Supply	220V 50Hz	220V 50Hz
Capacity (L/day) (Temp: 26.7°C; RH 60%)	12L	14L
Capacity (L/day) (Temp: 30°C; RH 80%)	20L	24L
Power Consumption (kWh/day)	6	6.6
Net Weight (kg)	13	13.3
Dimension (L x H x W) mm	380 x 570 x 175	380 x 570 x 175
Handle	Side hidden handle	Side hidden handle
Drainage	Continuous Drainage	Continuous Drainage
Water Tank Capacity (L)	5L	5L
Water Full-Stop Capacity (L)	4.5L	4.5L
Refrigerant (g)	R134a (160g)	R134a (220g)

The actual product you have may differ in outlook, color and drawings from the manual, due to the update of the product. But please be assured such changes will not change the performance and use.



星級服務 STAR SERVICE
查詢熱線 Star Hotline
香港 Hong Kong : 2406 9138
澳門 Macau : 0800157

www.whirlpool.com.hk



此標誌表示使用過的電器及電子產品，不可混入一般家居廢物。
切勿嘗試自行拆解系統或組件，以免對你您的健康或對環境造成不良影響。
雪櫃應在專門的回收處理設施內進行循環回收和修復，並不可棄置於一般廢物流中。
請聯絡安裝技師、經銷商或本地授權機構以獲取更多資訊。

This symbol mark means that used electrical and electronic products shall not be mixed with general household waste. Do not try to dismantle the system and unit by yourself as this could have harmful effects on your health and the environment. Refrigerators must be treated at a specialized treatment facility for recycling and recovery and shall not be disposed of in the municipal waste stream. Please contact the installer, dealer or local authority for more information.