

Whirlpool

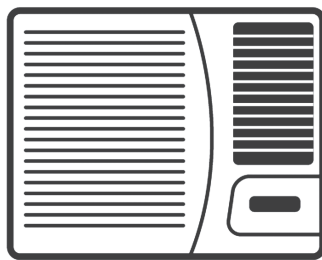

Health & Safety, Use & Care, Installation Guide and Online Warranty Registration Information

產品安全指引、使用說明、安裝指南及
網上登記保養資料

Model 產品型號： AWA07520N / AWA07520R
AWA09220N / AWA09220R
AWA18020N / AWA18020R



www.whirlpool.com.hk

Dear User,

Thank you for choosing Whirlpool air conditioner. Our design is based on the best efficiency and the lowest noise operation and it can keep the room comfortable. Please read this operating manual carefully before operating the unit and keep it for consultation.

Content

Product Structure and Installation	Function	1
	Safety Precaution	2-3
	Operating Condition	4
	Installation Instruction	5-7

Operation Procedure	Part Identification & Operation	8-14
	Operation Tips	15
	Caution	16

Care and Maintenance	17
Trouble Shooting Guide	18
After-Sales Service	19
Safeguarding The Environment	20

Please read this user manual carefully before operating the air conditioner.

The description in this user manual may differ from actual unit, please refer to the material objects for reference.

Introduction

Window type room air conditioners can regulate the room temperature and dry the room. It is convenient for your work, study and life. It can be widely used in residence, shop, hotel, office, library and laboratory, and so on.

Cooling in summer

In hot summer, air conditioner can cool down room air by transferring heat out.

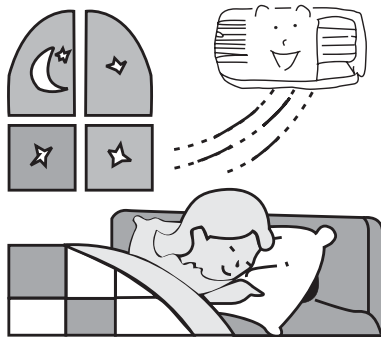

Dehumidifying in rainy or humid season

Without reducing room temperature, air conditioner can dehumidify and make room air dry and comfortable.



Exchange of fresh air

Open storm door to keep the fresh air in the room.



● *Safety Precaution*

- Read the safety precaution carefully before using this appliance.
- Incorrect operation will cause injuries and damage, please pay special attention to below sign:



- To prevent personal injury, injury to others and product damage.



- User should strictly follow the operating instructions. Or it may cause product damage or injuries.



- When using the appliances, should always follow this instruction to reduce the risk of fire, electric shock, and injury to person.
- Please keep this manual . If you deliver the appliance to other users , do handover this manual together.

Installation Precaution



- The appliance must be fitted with means for disconnection from the supply mains having a contact separation in all poles that provide full disconnection under overvoltage category III conditions, and these means must be incorporated in the fixed wiring in accordance with the wiring rules.
- The air conditioner must be installed by professional or qualified persons.
- The appliance shall be installed in accordance with national wiring regulations.
- The appliance shall be connected to electric supply with safety grounding .
The appliance must be connected to an electrical leakage protection switch with sufficient capacity .

● Safety Precaution



Operation Precaution	
 WARNING	<ul style="list-style-type: none">• This appliance is not intended for use by persons (including children) with reduced physical, sensory or mental capabilities, or lack of experience and knowledge, unless they have been given supervision or instruction concerning use of the appliance by a person responsible for their safety.• Children should be supervised to ensure that they do not play with the appliance.• If the supply cord is damaged, it must be replaced by a special cord or assembly available from the manufacturer or its service agent.• Do not use extension cord, otherwise it may cause fire hazard.• Do not pull the power supply cord to remove it from the socket. Do not twist or press the power supply cord, and make sure it is not broken.• Do not touch the power plug, circuit breaker and emergency button when your hands are wet.• Do not use flammable detergent to clean the appliance, such as gasoline, to avoid fire hazard.• Need two or more people to move and install the appliance to avoid excessive weight hazard.
 CAUTION	<ul style="list-style-type: none">• Disconnect power plug before cleaning, maintenance and servicing.• Disconnect power plug from power supply when the appliance is not in use for a long period of time.• Disconnect power plug when there is strange smell or abnormal noise from the appliance, and then contact service agency.

● Operating Condition

- Please operate air conditioner in the correct condition as followings.

COOL mode operation	DRY mode operation
<p>Outdoor temperature should be in range of 18 °C to 43 °C, otherwise it is possible for air conditioner to breakdown.</p> <p>Room humidity should be lower than 90% .</p> <p>Otherwise, it is possible for air conditioner to dew at air conditioner surface and even drop water after running for so much time. And this is a normal phenomenon.</p>	<p>Outdoor temperature should be in range of 18 °C to 43 °C, otherwise it is possible for air conditioner to breakdown.</p>

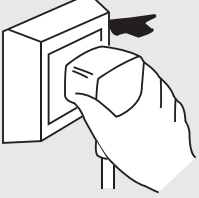
Power requirement

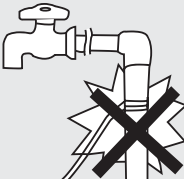
	<ul style="list-style-type: none"> * Make sure the voltage is 220V~240V, the ground must be connected. * If the voltage is too high, it may damage the electric components. * If the voltage is too low, the compressor will vibrate violently and damage the refrigerant system, the machine cannot be operate normally. 	
	<ul style="list-style-type: none"> * Special socket must be used. Furthermore, the socket and wiring must conform to the wiring regulations. And the earthing method must be reliable. * In fixed circuit, there must be electricity leakage protection switch of enough power capacity and air switch with enough space. 	
<p>Earth wire To ensure the reliable earthing, please do not connect earth wire to the following places:</p>		
<p>Water pipe</p>		

● Installation Instruction

Window type air conditioner is so valuable and the improper installation of it will cause a lot of damage!

Please associate the professional technician to install the unit and don't install it by yourself.

Location:

- The condensation water must be drained away conveniently.
- Install air conditioner unit far away from TV set or radio etc. to avoid disturbing video or voice.
- In salt and coastal area or place where is near thermal springs and polluted by sulphurous gas, or other special areas, please contact the seller before use.
- Avoid a place where is possible for inflammable gas to leak out.
- It's not allowed to be installed on the unstable or motive base structure (such as truck) or in the corrosive environment (such as chemical factory).
- Avoid other heat sources or direct sun light.
- Avoid a place where is easy for children to touch.
- Don't use the unit in the immediate surroundings of a laundry, a bath, a shower or a swimming pool.
- For window type air conditioner with remote control, install in a location where is strong electromagnetic disturbance, you should contact the seller in advance to avoid the malfunction in use.

How to install:

- Choose a location where there are no any obstacle surrounding the unit, and the plug is accessible.
- Prepare the installation hole slightly bigger than unit size.
- Choose the installation space according to the following diagram.

Product Dimension:

Model	W	H	D
7K/9K	450	350	580
18K	660	428	700

Unit:mm

The distance between the air conditioner and the around obstacles should meet the requirement as below: over 150mm (upper side), over 150mm (left side), over 150mm (right side) and over 500mm (rear side).

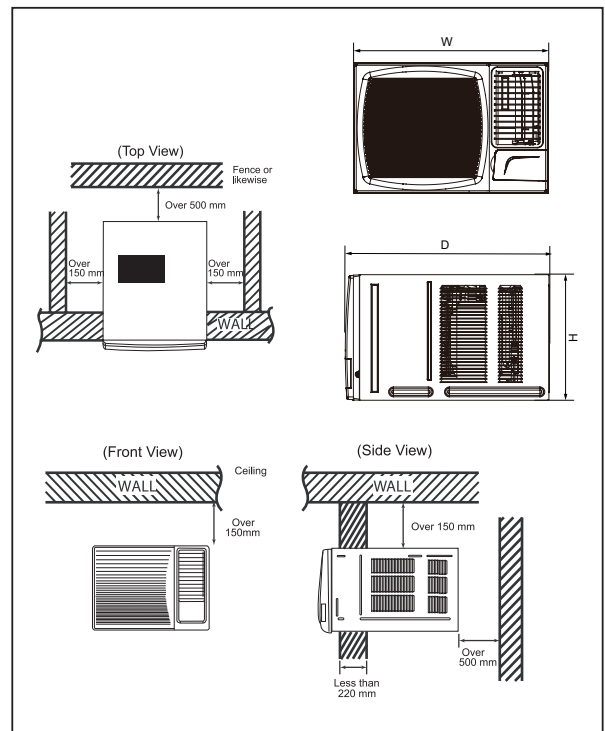

● Installation Instruction

Installation procedure:

- 1) Remove the sticker from the front panel.
- 2) Put the unit into the installation hole.
 - When installing the unit, it should be slanted down to the back to avoid the enlargement of noise or vibration. (Slant between 6-10mm.) (Shown at right figure.)
 - The installation place should be strong enough to avoid the enlargement of noise or vibration.
- 3) Fill up sews in the cabinet with sponge or foam.

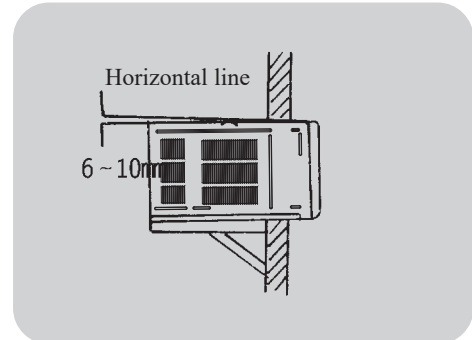

Installation assistance:

- Use iron support
The installation hole should be strong enough to support the air conditioner. If it cannot, iron support has to be used outdoors.
Iron support should be fixed on the building (Shown at right figure.)
- Use sunshade board
Air conditioner should avoid anything to be dropped into it and avoid direct sunshine. If there is no cover on it, you should contact the seller for installing the sunshade board. When installing the sunshade board, don't let it block the air inlet at the side grille.

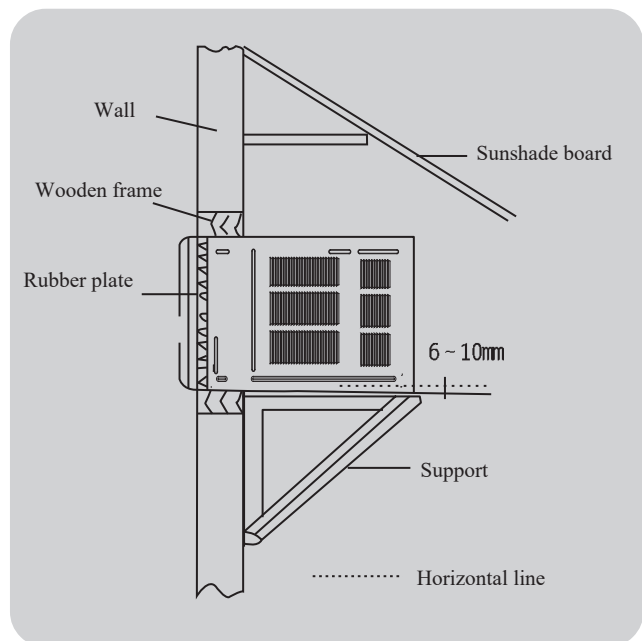

Drain water:

To get the maximum cooling efficiency, the air conditioner is designed to splash the condensation water on the condenser coil.

If the splashing sound annoys you, you can provide an outside drain by using the following procedure, which may however cause a small loss of performance.

1. Slide out the chassis from the cabinet.
2. Remove the rubber plug from the body base plate.
3. Install the drain pan to the corner of the cabinet with 2 screws.
4. Connect the drain hose to the outlet on the drain pan bottom.
5. Ensure the drainage work well, pour 2-3 cup of water into the drainage system.
6. Slide the chassis into its original place in the cabinet.

● Installation Instruction

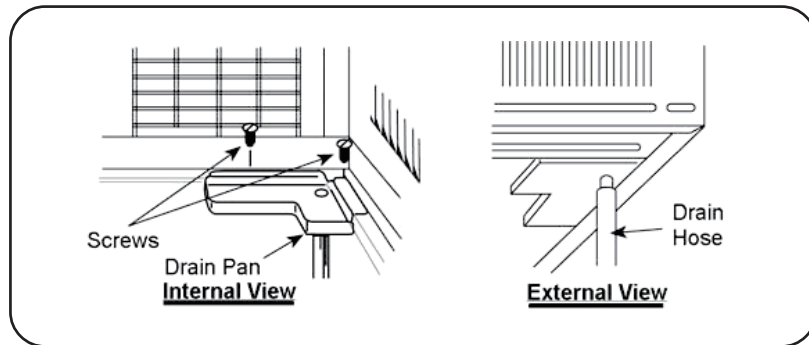

Note:

- Drain pan and drain hose must be installed before using reverse cycle models.
- Drain hose or tubing can be purchased locally to satisfy your particular needs.

Notes for installation

Remove

Before removing air conditioner to the other place, you should contact the seller firstly. Then it must be done under the direction of the professional technician.

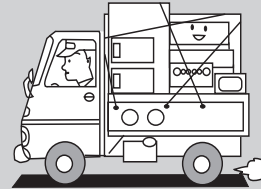

Noise

- Install in a location where is firm enough to avoid the enlargement of noise and vibration.
- Don't put anything in front of the outlet of the unit to avoid increasing noise.
- Be sure that hot air or noise will not inconvenience neighbors.
- Please contact the seller as soon as there is strange noise during operation.
- Please use the safety support.



Electric wiring

- Must connect with ground reliably.
- The exclusive circuit must be used. But removable socket can't be used because poor contact of it can cause over heat or fire.
- Don't pull the power cord strongly.
- In fixed circuit, there must be electricity leakage protection switch and leakage current is less than 30mA.
- Connecting method between air conditioners and power cord and interconnecting method of each individual element with one another should accord with wiring diagram on the unit.
- The air conditioner should be installed in accordance with national wiring regulations.
- An all-pole disconnection switch having a contact separation of at least 3mm in all poles should be connected in fixed wiring
- Air switch (thermal-magnetic breaker) should be installed in the circuit and its capacity is 10A for 7K and 9K, 20A for 18K.
- If the supply cord is damaged, it must be replaced by the manufacturer or your dealer or a qualified person to avoid a hazard.
- All the electrical work must be done according to the local wiring regulations.



● Parts Identification & Operations

Electronic

Panel outlook picture, just for reference, please take the real until as standard.

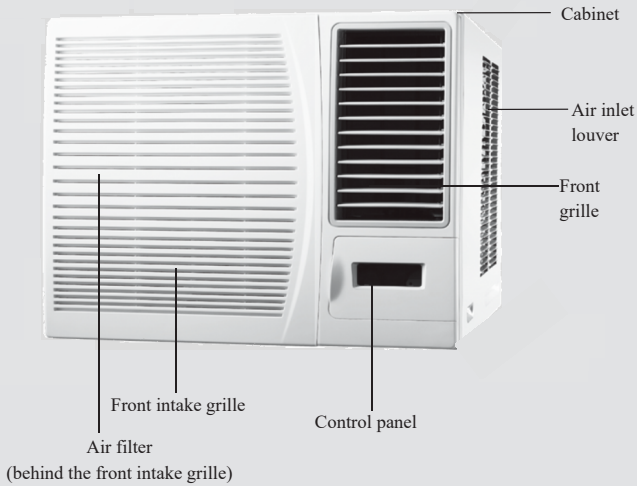

Mechanical

Panel outlook picture, just for reference, please take the real until as standard.

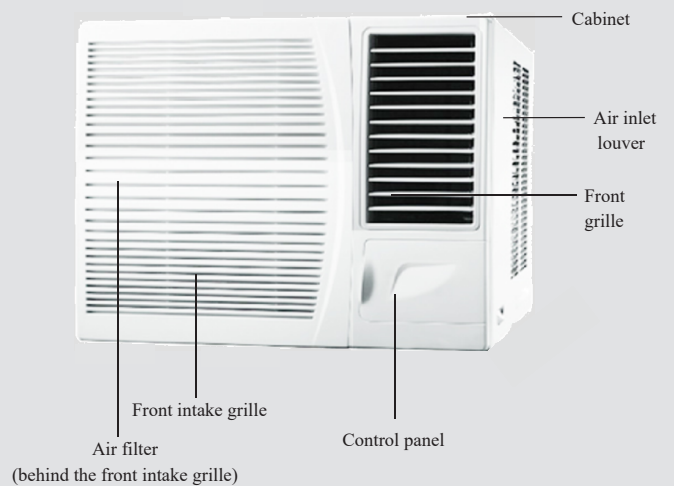

Vertical airflow direction vane

The vertical airflow direction vane is controlled by positioning the vane to discharge the air upwards, downwards or straight out.

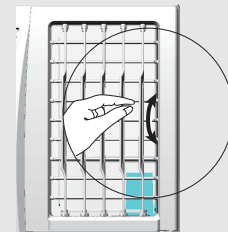

Ventilation Lever

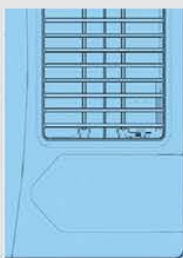

When the slide lever at the :



- "OPEN" position, the ventilation door opens to allow air, smoke or odors to be expelled from the room.

When the slide lever at the :



- "CLOSE" position, the ventilation door is closed and the air will be circulated inside the room and conditioned.

● Parts Identification & Operations

For Mechanical only

Applicable Models : AWA07520N/ AWA09220N/ AWA18020N

Main Control Panel

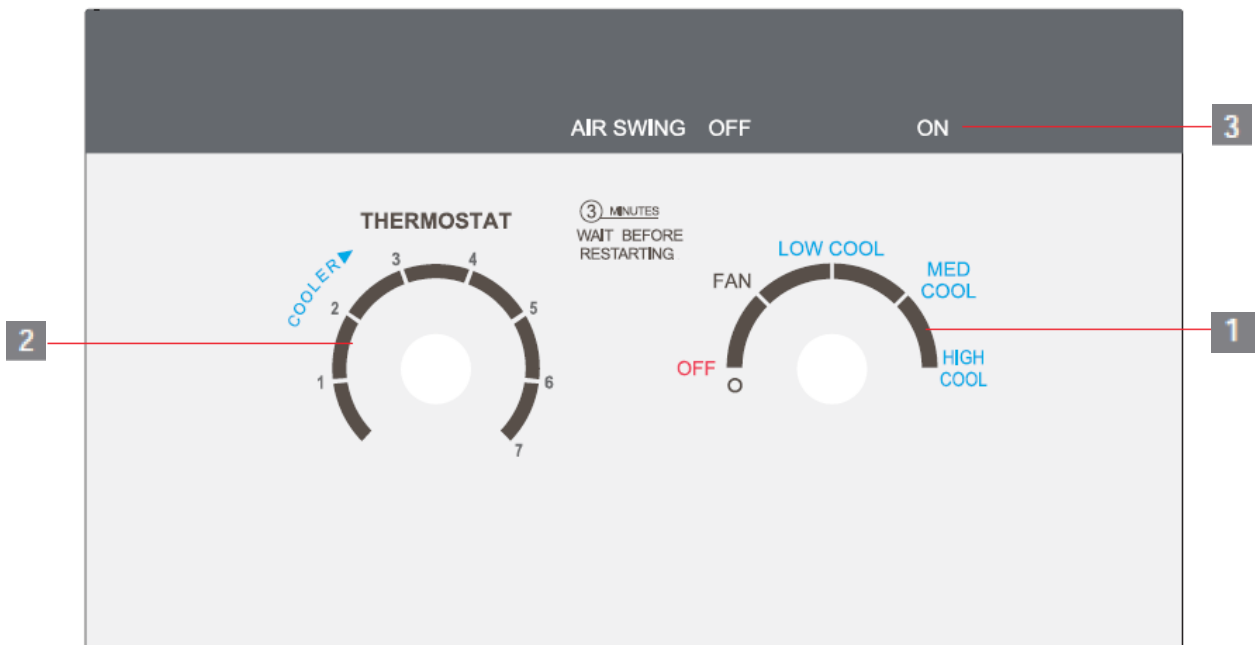

1. Operation Mode Selection Knob

- OFF – Stop the operation.
- FAN – Fan operation
- LOW COOL – Cooling operation at low speed
- MED COOL - Cooling operation at medium speed
- HIGH COOL - Cooling operation at high speed



- 2. Thermostat Control Knob** – Setting the desired temperature (recommend 4-5). If the room temperature is not as desired after a reasonable period, turn the thermostat control knob clockwise to cooler the indoor temperature.

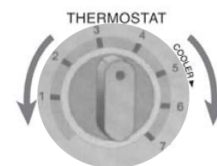

- 3. Air Swing Switch** – To obtain a fix airflow direction, set the air swing switch to “ON” for the vanes to swing from side to side until the desired flow direction is reached, then switch it to “OFF”. For continuous side-to-side air circulation, set the air swing switch to “ON”.



● *Parts Identification & Operations*

For Electronic only

Applicable Models : AWA07520R/ AWA09220R/ AWA18020R

Main Control Panel

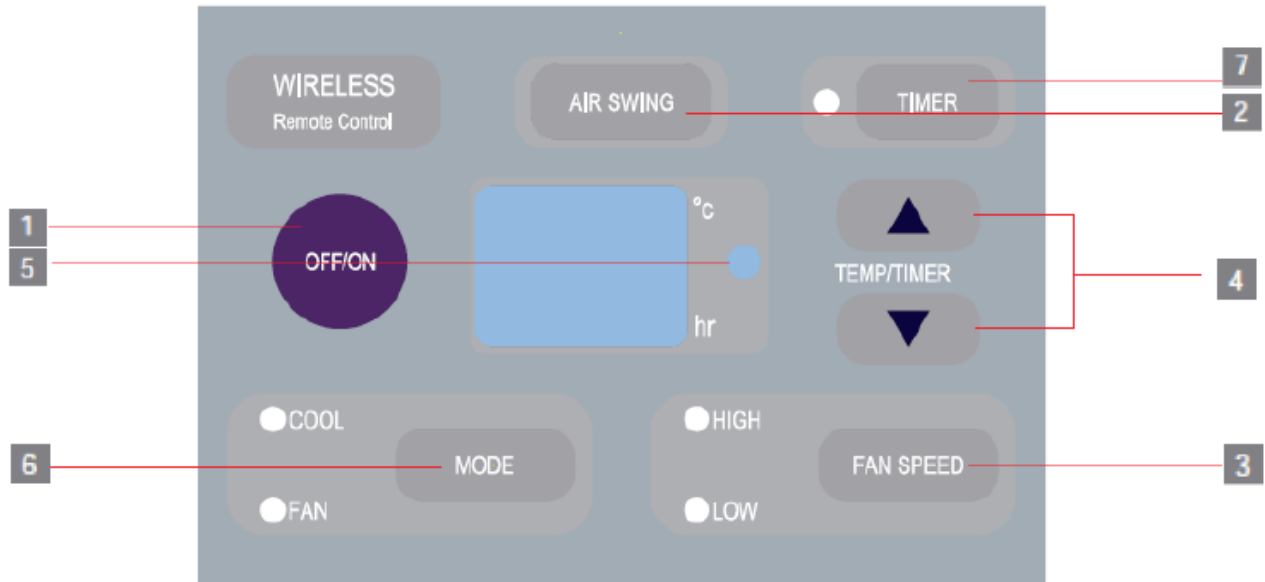

1 Power button

Press this button to turn on the unit. Press this button again to turn off the unit.

2 Swing button

Press this button to start up the auto swing function.

3 Fan speed button

Press this button to select fan speed (High/Low).

4 Temp/time button

Press ▲ button to increase set temperature and press ▼ button decrease set temperature. The temperature adjusting range is 16-30°C.

5 Signal receivers

6 Mode button

Press this button select operation mode: COOL, FAN.

7 Timer

After pressing TIMER button, press ▲ button and time can be set in 1-hour increments. Press ▼ button and time can be set in 1-hour decrements. The time adjusting range is 0-24hours.

● *Parts Identification & Operations*

Remote Control



- 1 Power button**
Press it to start or stop operation.
- 2 Mode button**
Press it to select operation mode (6TH SENSE/COOL/DRY/FAN).
- 3 -** : Press it to decrease temperature setting.
- 4 +** : Press it to increase temperature setting.
- 5 Fan speed button**
Press it to set fan speed.
- 6 Swing button**
Press it to set swing angle.
- 7 Sleep**
- 8 Timer**
Press it to set auto-on/auto-off timer.

Note:

- Be sure that there are no obstructions between receiver and remote controller.
- Don't drop or throw the remote controller.
- Don't let any liquid in the remote controller and put the remote controller directly under the sunlight or any place where is very hot.

● *Parts Identification & Operations*

Introduction for buttons on remote controller

1 Power button :

Press this button to turn on the unit. Press this button again to turn off the unit.

2 Mode button :

Each time you press the button, a mode is selected in a sequence that goes from 6TH SENSE, COOL, DRY, FAN, as the following:



*When it turns to 6th sense, display screen will show the words "Auto", and the temperature will set at 25°C.

*Dry mode will operate at low fan speed level.



3 - :

Press this button to decrease set temperature. Hold it down for above 2 seconds to rapidly decrease set temperature. In 6TH SENSE mode, set temperature is not adjustable.

4 + :

Press this button to increase set temperature. Hold it down for above 2 seconds to rapidly increase set temperature. In 6TH SENSE mode, set temperature is not adjustable.

5 Fan speed button :

This button is used for setting Fan Speed in the sequence that goes from 6TH SENSE, ,  to , then back to Auto.

If it is not a specific model, the speed 1 or speed 2 refer to low cool fan speed, while speed 3 or speed 4 refer to high cool fan speed.



6 Swing button:

Press this key to activate or deactivate the swing.

7 Sleep:

Press this button to go into the SLEEP operation mode. Press it again to cancel this function.

This function is available in COOL, or DRY mode to maintain the most comfortable temperature for you.

During SLEEP mode, set temperature will increase 1°C after 1 hour, increase 1°C more after 2 hours then keep steady.

8 Timer:

Press this button to initiate auto-on/auto-off timer. To cancel auto-timer program, press this button twice.

9 Combination of "+" and "-" buttons : About lock

Press "+" and "-" buttons simultaneously to lock or unlock the keypad.

● *Parts Identification & Operations*

Note:

- This is a general use remote controller, it could be used for the air conditioners with multifunction; For some function, which the model doesn't have, if press the corresponding button on the remote controller that the unit will keep the original running status.
- When power is connected(stand by condition), you can operate the air conditioner through the remote controller.
- When unit is on, each time you press the button on remote controller, the sending signal icon "📶" on the display of remote controller will blink once. If the air conditioner gives out a beep sound, it means the signal has been sent.
- When unit is off, set temperature will be displayed on the remote controller (If the light of indoor unit display is turned on, the corresponding icon will be displayed); When unit is on, it will display the icon of the on-going function.

● *Parts Identification & Operations*

Replacing batteries in remote controller

1. Remove the cover from the back of the remote control. To avoid small parts choking hazard, it is suggested to open the cover by tools (e.g. flat screwdriver).

- Insert the screw tap at the gap of latch.
- Slightly push the latch and pry the cover up to remove it.

2. Take out old batteries.

3. Insert the two batteries (Two AAA dry - cell batteries).

4. Re-attach the cover. (Shown as diagram)

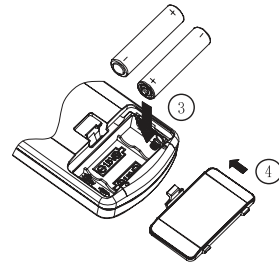
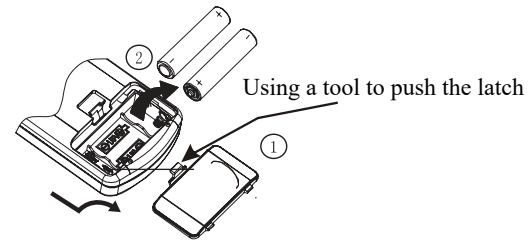

NOTE:

- Don't mix the new and worn or different types of batteries.
- Remove batteries when the remote controller is not in use for a long time.
- The remote controller should be placed about 1m or more away from the TV or any other electric appliances.
- As the signal will be interfered in the room with electronic fluorescent lamp, conversion fluorescent lamp or wireless phone, please get closer to the air conditioner when using the remote controller.

● Operation Tips

Operation for comfort and economy

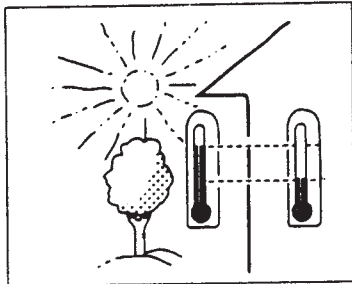

Do not overcool the room temperature. This is not good for health and waste electricity.

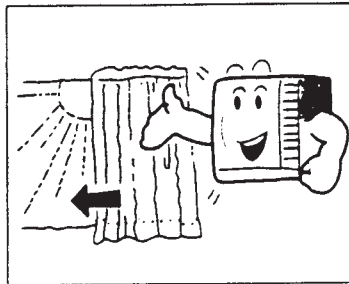

Keep blind or curtains closed
Do not let sunshine enter the room directly when the air condition is in operation.

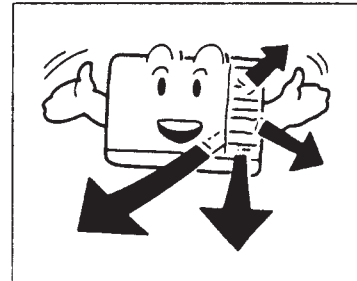

Keep the room temp. uniform.
Adjust the vertical and horizontal airflow direction to ensure a uniform temperature in the room.
Air can't be discharged to the direction of air-in.

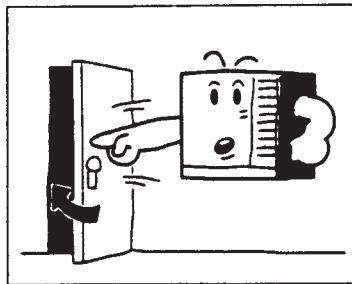

Make sure that the doors and windows are tightly closed. Avoid opening doors and windows as much as possible to keep air conditioning in the room.

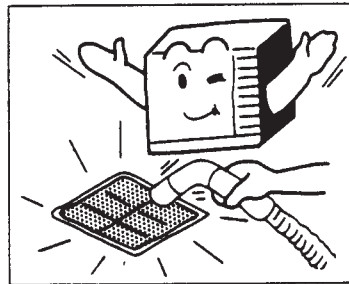

Clean the air filter regularly.
Blockages in the air filter reduce dehumidifying effects. Clean the air filter at least once every two weeks.

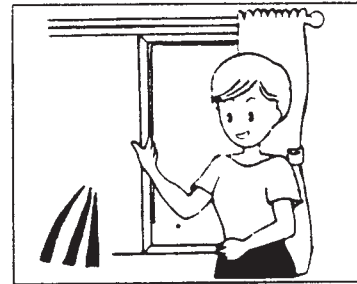

Ventilate the room occasionally.
Since windows are kept closed, it is a good idea to open them and ventilate the room now and then.
When starting the unit, curtains or windows should be closed to prevent the heat/cool leakage.

Note:

- In silent environment, during operation to be started or stopped, there may be rubbing noise to be generated from fan guide and housing;
- During refrigeration cycle, the refrigerant flowing sound may be generated occasionally. This phenomena is normal.
- There is condensed water to be formed at evaporator and accumulated at the bottom tray. The water will be splashed to condenser through condenser fan blade. "Splash" sound may be created. This phenomena is normal.

● Caution

Operation for safety and health

- 1) The plug must be accessible after the appliance is positioned.
- 2) Do not use this appliance in the laundry room.
- 3) If the power cord is damaged, it must be replaced by the manufacture or its service agent in void of hazard.

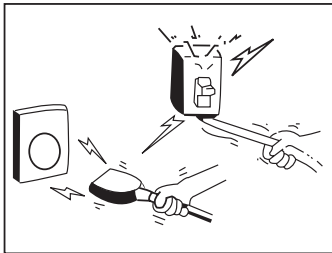

Do not pull out the power cord. Damage to the cord may result in serious electric shocks.

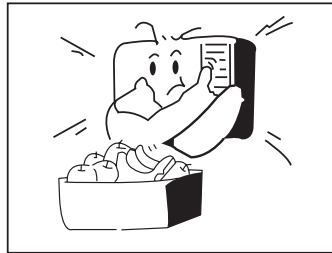

Do not use the air conditioner for other purposes except for cooling the room. Do not use the air conditioner for other purposes such as drying clothes, preserving foods, or cultivating vegetables.



Do not block the air intake and outlet vents. This causes lowered performance and irregular operation. Do not insert sticks or other objects into these vents as it is dangerous to touch the electric components and the fan.

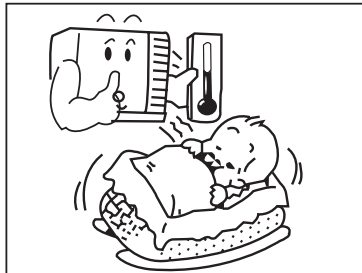

Select the most appropriate temperature. Pay attention to adjust the temperature to suit the conditions. Rooms occupied by infants, the elderly, or the sick should be kept at an appropriate temperature.

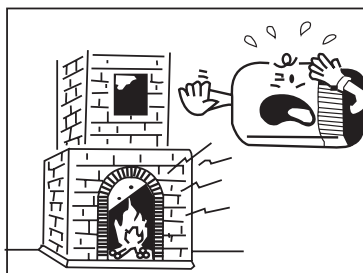

Do not use heating apparatuses in the vicinity. The air conditioner's plastic parts will melt if exposed to excessive heat.

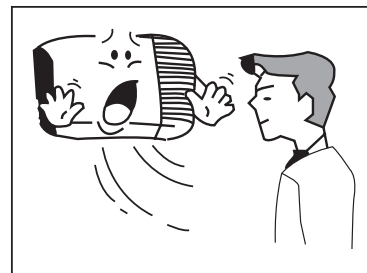

Avoid exposing the body directly to a continuous unidirectional air flow for long periods. This is not recommended for health reason.

Always wait at least 3 minutes before switching the air condition on again after you have switched it off during cooling. The appliance should not be used by children without supervision.

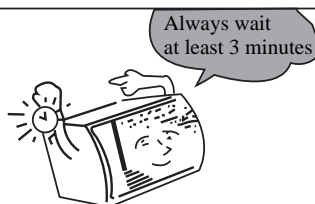

● Care and maintenance

Cleaning unit

1. Cut power off before cleaning.

Plug out only after air conditioner stops at all.

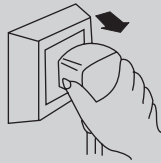

2. Use soft cloth when cleaning cabinet.

If the cabinet is very dirty, dip cloth into warm water below 40 °C dry the cloth and then rub off the dirt.



Dry the cloth by hands before cleaning.

3. Don't use gas, benzene, solvent, wash, chemical solvent, etc. for cleaning.



4. Do not splash water directly into the unit, in which there are micro-computer and circuit plate, they must not be drenched with water.



Air filter

The air filter behind the intake grille should be washed at least once every two weeks or as often as it needs cleaning.

How to clean the air filter:

1. To remove the air intake grille, grasp the tab on the filter and pull to take out.



2. Vacuum the filter on the dusty side to remove light dust.

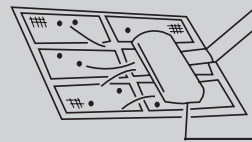

Vacuum cleaner

3. Wash the filter, cleaner side up under gently flowing water to wash out accumulated dust and lint.



4. If the filter is very dirty, use a mild household detergent in the wash water.



Let the filter dry thoroughly before reinstalling it. If necessary, please ask the professional personnel to clean it.

* Check earth wire

Is it broken or loose?

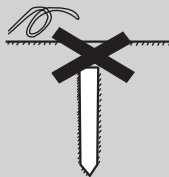

* Check if air inlet and outlet of the unit are blocked or not.

Air lock could result in bad efficiency.







Note:

Always turn off the air conditioner and main power supply before cleaning to ensure safety.

● Trouble shooting guide

Please check the following items before asking for repair, it saves your time and money.

Fault phenomenon	Troubleshooting
<p>Air conditioner does not operate at all.</p> 	<ul style="list-style-type: none"> * Is there a power failure? * Is the plug out? * Is power fuse or switch off? * Is the power voltage too high or too low?
<p>Cool efficiency is not good.</p> 	<ul style="list-style-type: none"> * Is air inlet or outlet locking? * Is there any other heat source in room? * Are air filters very dirty? * Is indoor fan speed set at LOW? * Maybe the room is too hot when the unit is started, please cool down the room after a period of time. * Is there direct sunlight?
<p>Foggy air flows out.</p> 	<ul style="list-style-type: none"> * At COOL mode operation, sometimes there is foggy air flowing out of the unit, this is because the room humid air has been cooling rapidly. * The unit is normal while the indoor outlet is sending out some odor, because the inlet air may be mixed with the smell of furniture and smoke.
<p>The air conditioner operation is noisy.</p> 	<ul style="list-style-type: none"> * For a noise that sounds like water flowing: This is the sound of freon flowing inside the air conditioner unit. * For a noise that sounds like a shower: This is the sound of the dehumidifying water being processed inside the air conditioner unit.
<p>It seems that condensation is leaking from air conditioner.</p>	<ul style="list-style-type: none"> * Condensation occurs when the airflow from the air conditioner cools the warm room air.
<p>Air conditioner does not operate for about 3minutes when restart.</p>	<ul style="list-style-type: none"> * This is to protect the mechanism. * Wait about three minutes and operation will begin.

● *After-sales Service*

Immediately stop all operations and plug out, please contact your dealer in the following situations.

- *Operation starts or stops abnormally;
- *Power fuse or switch often breaks;
- *Carelessly splash water or something into air conditioner;
- *Electrical lines are much hot or lines cover breaks;
- *Other strange situations.



Scrapping Notice

Scrapping Packaging

1. The packaging can be 100% recycled as confirmed by the recycling symbol . The various parts of the packaging must not be dispersed in the environment, but must be scrapped in line with local authority regulations.
2. This product contains Fluorinated Greenhouse Gases covered by Kyoto Protocol , the refrigerant gas being in hermetically sealed system . Refrigerant gas : R410a has a Global Warning Potential (GWP)1975.
3. For more detailed information on handling and recycling of this product and its' packaging, contact your local authorities who deal with the separate collection of rubbish or the shop where you bought the appliance.

Scrapping Appliance

4. This appliance has been made of recyclable or re-usable material. Scrapping must be carried out in compliance with local waste disposal regulations. Before scrapping it, make sure to cut off the mains cord so that the appliance cannot be re-used.



5. The symbol on the product or on the documents accompanying the product indicates that this appliance should not be treated as household waste, but must be given to the appropriate local gathering place where electric and electronic appliances are stored and recycled.
6. The batteries in remote controller must be recycled or disposed of properly. Please discard the batteries as sorted municipal waste at the accessible collection point. (remark : only for product with remote controllers)

尊敬的用戶：

感謝閣下選購惠而浦冷氣機。我們本著最佳效能、最低操作噪音及令房間變得舒適的宗旨來設計冷氣機。請在操作冷氣機前，小心閱讀本操作手冊，並適當保存以作日後參考。

目錄

結構及安裝	功能	-----	22
	安全注意事項	-----	23-24
	操作條件	-----	25
	安裝指引	-----	26-28

操作步驟	名稱及操作說明	-----	29-35
	操作指南	-----	36
	注意事項	-----	37

保養及維修	-----	38
故障排除指南	-----	39
售後服務	-----	40
保護環境	-----	41

請在操作冷氣機前細心閱讀本操作手冊。

本手冊內的圖示可能與實物有所差異，請根據實物以作參考。

● 功能

簡介

窗口式冷氣機能調節室溫及具除濕效能，為你的工作、溫習及生活帶來便利。冷氣機能廣泛運用在住宅、商舖、酒店、辦公室、圖書館和實驗室等地方。

在夏季中製冷

在炎熱的夏日，冷氣機可透過抽走熱力來冷凍房間。

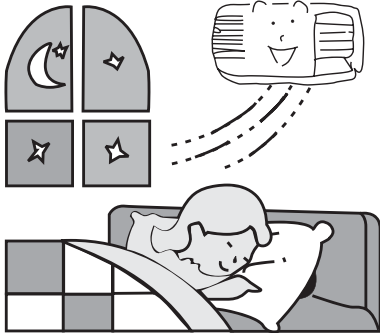

在雨季或潮濕天氣中除濕

冷氣機能在不降低室溫的情況下除濕，令房間更乾爽及舒適。



交流新鮮空氣

打開風門來保存室內的新鮮空氣。



● 安全注意事項

- 使用前請仔細閱讀說明書。
- 不正確的操作會導致人身傷害和損害，請特別注意以下指引：



- 為了防止人身傷害，傷害他人及產品損壞



- 用戶應嚴格按照使用說明書。它可能會導致產品損壞或人身傷害



- 使用電器時，應遵循本說明書的要求，以減少火災、電擊和受傷的風險。
- 請保管好本說明書，如需將產品交給他人使用，請將說明書一同轉交。

安裝注意事項



- 在家中的固定接線系統中需有配有一個符合國家佈接線要求的全極斷開開關，以便使用時能斷開。
- 冷氣機必須由專業人士或合格的人員進行安裝。
- 安裝產品時需嚴格按照國家的接線要求進行。
- 本產品必須接地，且需要接上容量足夠的漏電保護開關。

● 安全注意事項



操作注意事項	
 WARNING	<ul style="list-style-type: none">● 本產品不能由無行為能力, 或缺乏經驗和知識的人士使用(包括兒童), 除非他們已獲得由負責他們安全的人就使用本產品進行監督或指導。● 監護人應確保小孩不能將本產品當成玩具使用。● 如果電源線損壞, 為了避免危險, 必須由製造商或指定的維修部門的專業人員更換。● 嚴禁使用拖線插座供電, 以免產品著火。● 切勿以拉扯電線的方式來拔出插頭。使用時切勿扭曲或用力按壓電線, 並確保電線沒有損毀。● 手濕時切勿觸摸插頭、漏電斷路器和緊急操作按鈕。● 不能使用汽油等易燃清潔劑產品進行清洗, 否則會有火災的風險。● 為了避免本產品太重造成傷害, 需2個人或以上移動和安裝本產品。
 CAUTION	<ul style="list-style-type: none">● 在清洗、維護及維修前需拔下電源插頭。● 如長時間不使用本產品, 需拔下電源插頭。● 當產品有異味或異音時, 請斷開電源並與售後服務聯繫。

● 操作條件

- 請按照以下的正確步驟，操作冷氣機。

製冷模式操作 (COOL Mode)	乾燥模式操作 (DRY Mode)
室外溫度應該在18°C至43°C之間，否則，冷氣機可能出現故障。 房間濕度應低於90%，否則冷氣機表面會出現水珠，又或當運行一段長時間後，會出現滴水情況，但這屬正常現象。	室外溫度應該在18°C至43°C之間，否則，冷氣機可能出現故障。

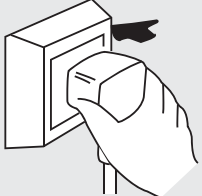
電力要求

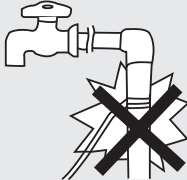
	<ul style="list-style-type: none">* 額定電壓和電壓範圍：220V-240V，地線必須連接。* 若電壓過高，會損毀電器組件。* 若電壓過低，壓縮機會強烈震動和損毀冷凍劑系統，並會令壓縮機及電器組件不能正常運作。	
	<ul style="list-style-type: none">* 要使用特別的電源插座，而且電源插座和線路圖必須符合線路條例，接駁地線的方法必須可靠。* 在固定電路中，必須有漏電保護開關，當中必須有足夠的電力容量，而空氣開關必須有足夠空間。	
地線	要確保有可靠的地線連接，切勿將地線接駁到以下地方：	
	水龍頭	

● 安裝指引

安裝前請移除所有包裝材料。請由專業的技術人員來安裝設備，否則可能會損壞冷氣機。

位置:

- 冷凝水必須能方便地排走。
- 安裝冷氣機時，請遠離電視或收音機，以免對影像和聲音造成干擾。
- 在充滿鹽份和海岸地區或靠近溫泉的地方，又或容易受硫磺氣體污染的場所，及其他特別地方，在使用冷氣機前，請聯絡零售商。
- 避免放在易燃氣體容易洩漏的地方。
- 請勿將冷氣機安裝在不穩定或會移動的地方(如大型車輛)，又或容易受侵蝕的地方(如化學工場)。
- 避免放在熱源或受陽光直射的地方。
- 切勿將冷氣機放在洗衣房、浴室、淋浴間、泳池附近等地方。
- 避免放在兒童容易接觸到的地方。
- 若閣下購買有遙控器的冷氣機，當它安裝在有強力電磁干擾的地方時，在使用前，應先聯絡零售商以防止出現故障。

安裝時注意事項:

- 安裝在適當的位置，以避免操作時產生震動和噪音。請選擇一個周圍沒有障礙物及容易接觸到插頭的安裝位置。
- 請準備一個稍為大於冷氣機尺寸的安裝孔口。
- 請根據下圖選擇安裝位置。

產品尺寸:

型號	W	H	D
7K/9K	450	350	580
18K	660	428	700

單位:毫米

冷氣機與四周障礙物的距離應達到以下要求:
大於150毫米(上面), 大於150毫米(左面), 大於150毫米(右面),
大於500毫米(後面)。

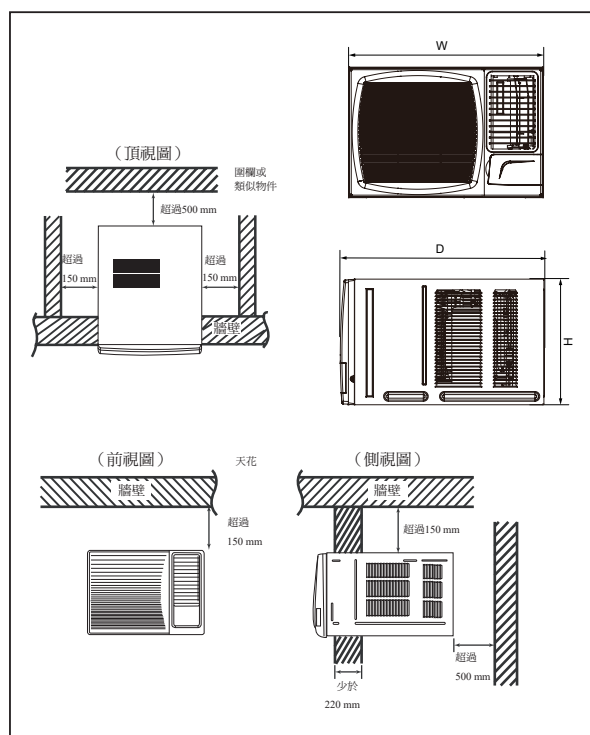

● 安裝指引

安裝步驟：

- 1) 從前面板撕去貼紙。
- 2) 將冷氣機放入安裝孔口。
 - 當安裝冷氣機時，應向後滑入安裝，以防止增加噪音和震動（傾斜6-10mm）（如右圖所示）。
 - 冷氣機的安裝位置應夠穩固，以防止增加噪音和震動。
- 3) 使用海綿將框架內的空隙填滿。

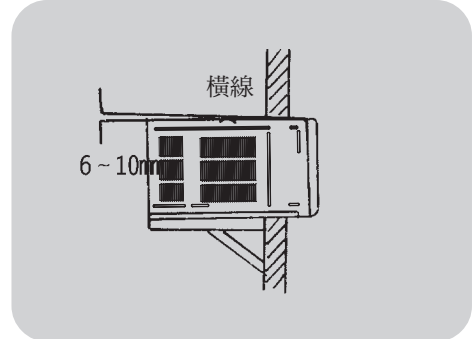

安裝配件：

- 使用承托支架
安裝孔口必須堅固，可以承托整部冷氣機，若不穩固，可在室外使用鐵架支撐。鐵架應固定在建築物外牆（如右圖所示）。
- 使用太陽擋板
應防止冷氣機上面有物件意外掉下或受陽光直射。若冷氣機上面沒有上蓋，應聯絡零售商安裝太陽擋板。當安裝太陽擋板時，切勿阻礙側面格柵的空氣吸入口。

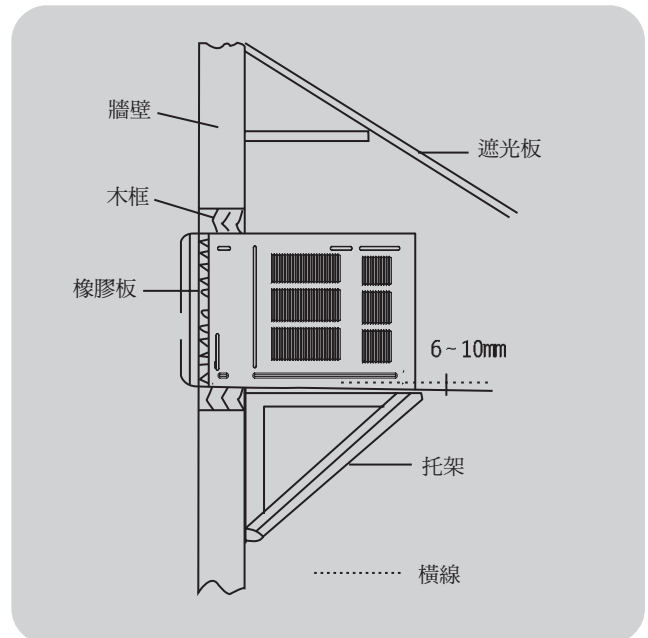

排水：

要獲得最大的製冷效果，冷氣機的設計，是可以讓冷凝水濺落在冷凝器線圈上。若濺水聲令你煩擾，你可根據下列步驟，安裝一個室外的排水系統，但製冷效果可能稍有影響。

1. 從冷氣機外殼滑出底盤。
2. 從機身底板上，移去塑膠塞子。
3. 用兩枚螺絲將排水盤安裝在機殼的角位。
4. 將排水管連接至在排水盤底部的排水出口上。
5. 在排水盤中倒入2-3杯水，以確保排水組裝正常。
6. 將底盤滑入機身的原來位置。

● 安裝指引

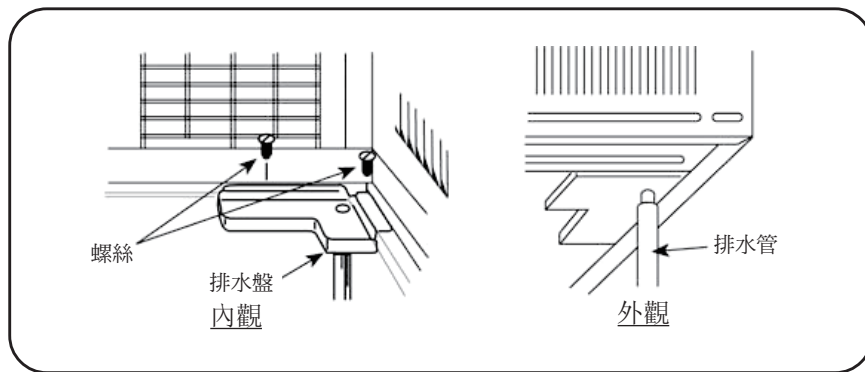

注意：

- 使用前必須安裝排水盤及排水箱。
- 你可在本地市場購買排水軟管以切合閣下的實際需要。

安裝注意事項

搬移

在搬移冷氣機到其他地方前，請先聯絡零售商。
搬移冷氣機時，必須按照專業技術員的指令進行。

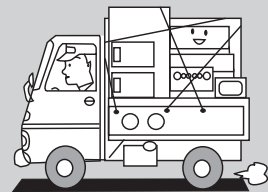

噪音

- 安裝在一個可減少噪音和震動的堅固位置。
- 切勿在室外機的出口前方放置任何物件，以減低噪音。
- 確保熱氣或噪音不會影響你的鄰居。
- 如操作時發出特殊聲音，請聯絡閣下的零售商。
- 使用安全的承托支架。

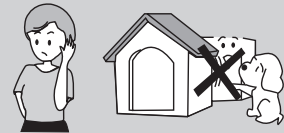

電器配線

- 必須連接可靠的地線。
- 必須使用特定的線路，切勿使用不穩固的插座，因不良接觸可能造成過熱或火災的危險。
- 切勿用力拉扯電源線。
- 在固定的電路上，應該安裝有漏電保護開關，而漏電電流應少於30mA。
- 應在電路安裝空氣開關（熱磁斷路器），7K和9K的負載能力是10A，而18K是20A。
- 應根據冷氣機的接線圖，使用適當的方法將冷氣機及電源線，以及每個獨立組件進行相互連接。
- 應根據國際電路規定安裝冷氣機。
- 一個全極斷電開關，在所有電極之間，應有3mm的接觸分離，並應連接到固定的線路之中。
- 若電源線被損毀，必須由生產商、零售商或合資格的技術人員進行更換以防止危險發生。
- 所有電氣工程必須根據本地的接線條例進行。



● 名稱及操作說明

電子式

冷氣機面板的外觀只作參考，請以實物作為標準。

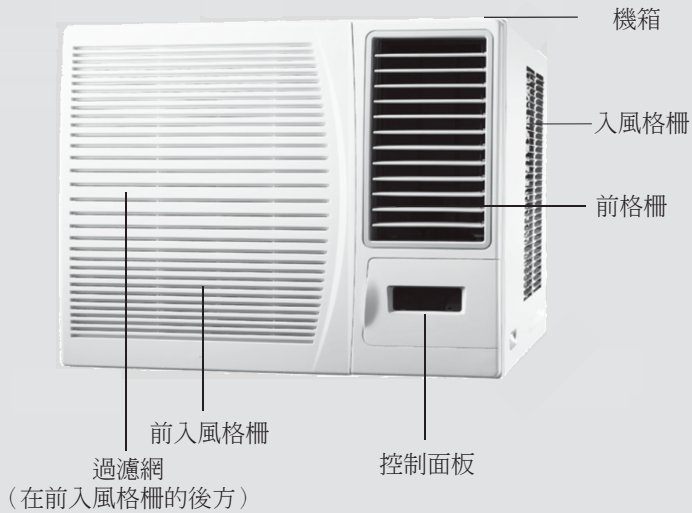

機械式

冷氣機面板的外觀只作參考，請以實物作為標準。

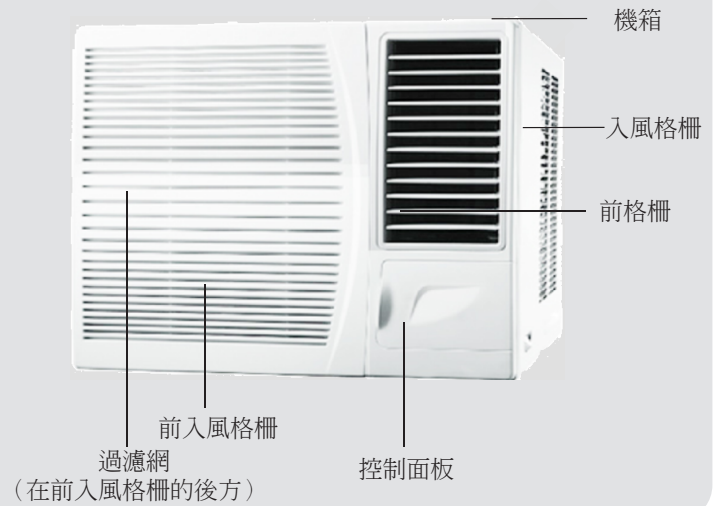

垂直出風翼片

通過調校翼片，便可垂直向上、向下或直出，控制出風方向。

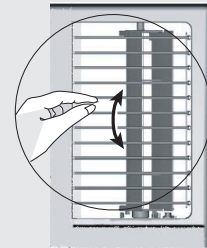

通風桿

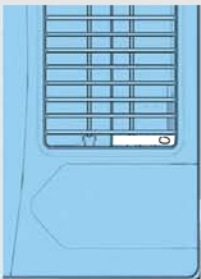

當滑動杆桿在 "OPEN"：



-在 "OPEN(開)" 的位置，通風門開啟讓空氣、煙或異味排出房間。

當滑動杆桿在 "CLOSE"：



-在 "CLOSE(關)" 的位置，通風門關閉，空氣將於室內流通及調節。

● 名稱及操作說明

只限機械式

適用型號 : AWA07520N/ AWA09220N/ AWA18020N

主控制面板

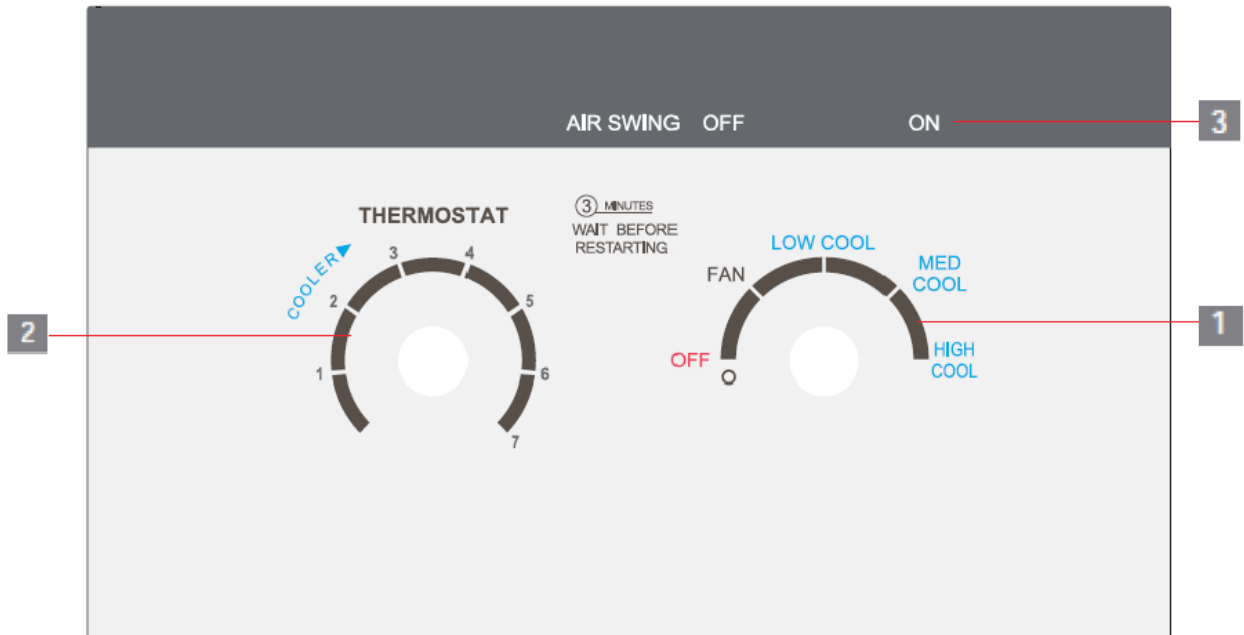

1. 主控制旋鈕

- OFF - 停止操作
- FAN - 送風設定
- LOW COOL - 低速製冷運轉
- MED COOL - 中速製冷運轉
- HIGH COOL - 高速製冷運轉



2. 恆溫器控制旋鈕

可按需要，設定恆溫器控制旋鈕（通常是4-5度）。當冷氣機操作一段時間後，房內溫度依然不理想，可將恆溫器控制旋鈕順時針方向旋轉，令房間溫度變得涼快，或逆時針轉動恆溫器令室溫提升。

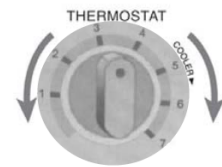

3. 擺風角度開關（左右調校風向位置）

如要固定出風方向，將擺風角度設定到ON（開）的位置，令其左右搖擺直至達到理想的出風方向，然後控下OFF（關）按鈕。如須要左右不停擺動，將擺風按鈕，設定至ON（開）的位置。



● 名稱及操作說明

只限電子式

適用型號 :AWA07520R/ AWA09220R/ AWA18020R

主控制面板

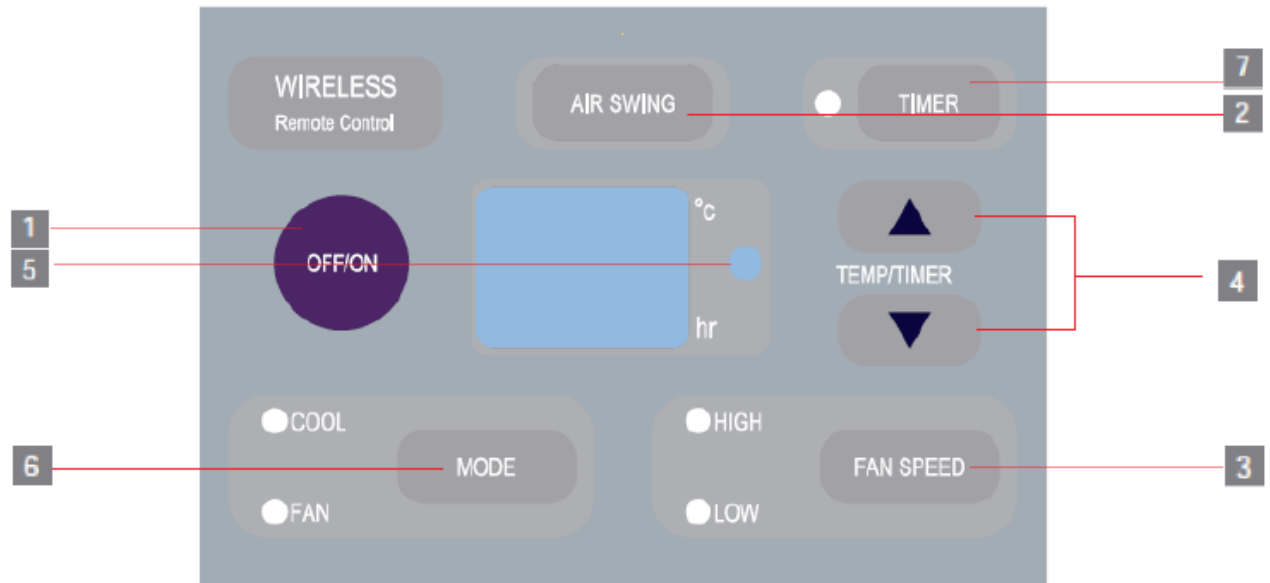

1 電源按鈕

當按下此按鈕，冷氣機會開始運作。再次按下按鈕，運作會停止。

2 擺風按鈕

啟動自動送風搖擺功能。

3 風速按鈕

按此按鈕選擇風速(高/低)。

4 溫度/時間掣按鈕

按下▲按鈕，以調高冷氣機的設定（操作）溫度，按下▼按鈕，降低冷氣機的設定（操作）溫度。溫度調節範圍由攝氏16至30度。

5 訊號接收器

6 模式按鈕

選擇操作模式，COOL（製冷）、FAN（送風）。

7 定時按鈕

先按下TIMER（定時）按鈕，按▲按鈕，以一小時為單位，增加已選的時間，按▼按鈕以一小時為單位減低已選的時間。時間設定範圍是由0至24小時。

● 名稱及操作說明

遙控器



- 1 **開/關**
按下此按鈕開啟或停止操作。
- 2 **模式**
每次按下此按鈕，選擇不同模式操作。
(第六感/製冷/抽濕/風速)
- 3 -
按下此按鈕減低溫度設定。
- 4 +
按下此按鈕提升溫度設定。
- 5 **風速**
按此按鈕設定風速大小。
- 6 **搖擺**
按下此按鈕設定搖擺角度。
- 7 **睡眠模式**
- 8 **時間制式**
按下此按鈕作選擇開啟/關閉時間設定。

注意:

- 請確保在遙控器與接收器之前沒有阻礙物阻擋。
- 請不要拋擲遙控器。
- 切勿在遙控器濺上任何液體以及將遙控器放在直射陽光及非常酷熱的地方。

● 名稱及操作說明

遙控器按鈕簡介

1 開/關

按下此按鈕開啟，再按下一次作關機。

2 模式

每次按下此按鈕，選擇模式將順序由第六感操作、製冷、抽濕至風速，顯示如下：



* 屏幕上將同時顯示“AUTO”字樣，而溫度將設定在25度。
除濕模式下，風速默認為低風檔。

3 -

按下此按鈕減低溫度設定，連續按下兩秒以上可加快減低溫度，在第六感模式時，溫度不能作手動調控。

4 +

按下此按鈕增加溫度設定，連續按下兩秒以上可加快增加溫度，在第六感模式時，溫度不能作手動調控。

5 風速

此按鈕用於調控風速，並將按以下次序運行，由第六感操作模式，再回到第六感操作模式。如非指定型號，當遙控顯示Speed 1或Speed 2，即代表是冷氣低速，而在speed 3或Speed 4時，即代表冷氣高速。

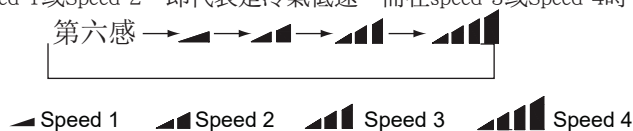

6 搖擺

按下此按鈕開啟或關閉搖擺功能

7 睡眠模式

按下此按鈕進入睡眠運作模式，再按一次作關閉此功能。此功能只適用於製冷或抽濕模式，為您提供最舒適的溫度。睡眠模式運作時，當冷氣機操作1小時後，設定溫度會上升1度，再操作2小時後，設定溫度會再上升1度，然後保持穩定。

8 時間制式

按下此按鈕作設定自動開啟/自動關閉，如要取消時間制操作，連續按下此按鈕兩次即可。

9 混合使用“+”和“-”按鈕：鎖定功能。

同時按下“+”和“-”按鈕，便可為遙控鍵盤作鎖定和解鎖。

● 名稱及操作說明

注意:

- 這是一款受普遍使用的遙控器，可用於多功能冷氣機。對於沒有某些功能的冷氣機，按遙控器上相應的按鈕，本機將會保持原來的運行狀態。
- 接上電源後(待機狀態下)，可使用遙控器操作冷氣機。
- 開啟冷氣機後，每按一次按鈕，遙控器顯示屏上發出信號圖示“”會閃爍。如果冷氣機發出“bee bee”聲，則代表已發出信號。
- 關閉冷氣機後，遙控器會顯示設定溫度(如果顯示屏燈在室內亮起，會顯示相應的圖示); 開啟冷氣機時，則會顯示正在進行的功能圖示。

● 名稱及操作說明

更換電池

1. 移除遙控器的電池蓋。為避免因小零件而引致窒息，請使用工具如一字螺絲批移除遙控器的電池蓋。
 - 先用螺絲批伸入扣位罅隙。
 - 輕輕施壓把電池蓋撬起。
2. 取出舊電池。
3. 放入兩枚AAA 1.5V 新電池，並留意其兩極性。
4. 重新把遙控器的電池蓋合上(如圖示)。

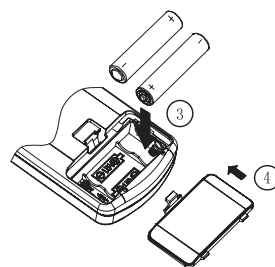
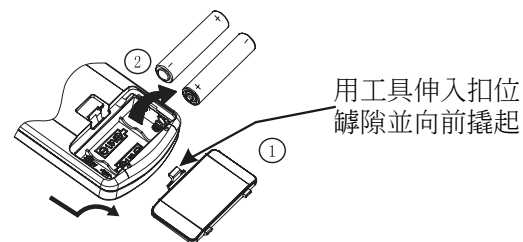

注意:

- 不要將新舊或者不同類型的電池混合使用。
- 當遙控器長時間不使用時，請將電池拆下。
- 電池的使用壽命是1年。
- 遙控器必須放置在遠離電視或者其他電器一米以上。
- 遙控器可能會受到光管、無線電話等信源影響，可靠近冷氣機以改善遙控器接收。

● 操作指南

經濟又舒適的操作

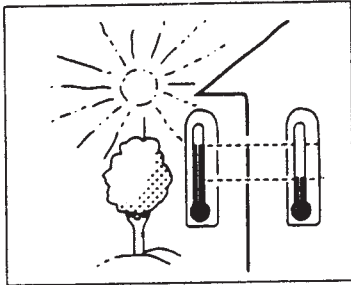

切勿令房間室溫過冷，以免影響健康，亦浪費電力。

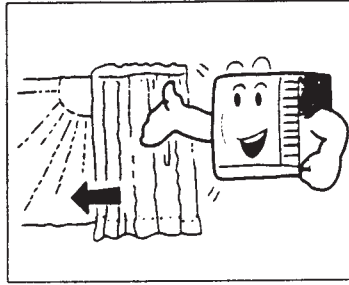

保持百頁簾及窗簾關閉。當冷氣機運作期間，不要讓陽光直接照射入室內。

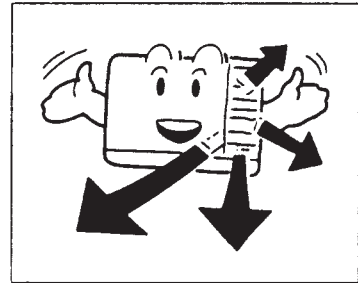

保持室溫均衡。垂直和橫向調整氣流方向，確保室溫均衡。空氣不能在流入的方向釋出。

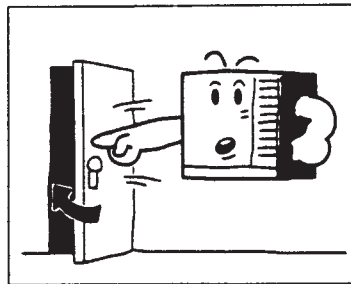

確保門窗關緊。儘量避免打開門窗，以保持冷氣在室內流動。

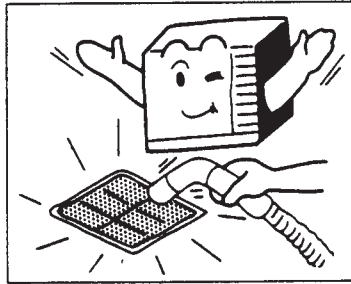

定期清潔空氣過濾網。若空氣過濾網阻塞，會減低除濕效果。至少每兩星期清潔空氣過濾網一次。

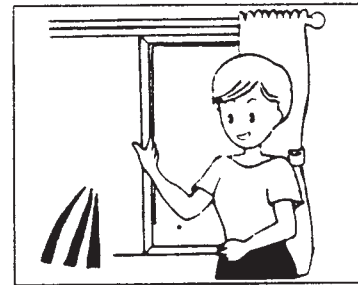

偶爾要排出室內的空氣。由於窗戶緊閉，應不時打開門窗以保持室內空氣流通。當冷氣機運作時，窗簾或門窗應關上，以免流失冷氣。

注意：

- 在寧靜的環境或停止運作時，風扇罩、外殼可能會產生因熱脹冷縮產生的摩擦聲。
- 冷凍劑流動的聲音亦有可能聽到。
- 凝結在蒸發器的水會在底盤裏收集。而冷凝器的風扇會將水淺向冷凝器造成正常的“滴水”聲。此現象屬正常。

● 注意事項

安全又健康的操作

- 1) 產品安裝後，一定要能接觸得到插頭。
- 2) 切勿在洗衣房內使用本產品。
- 3) 若電線損壞，一定要由製造商或維修代理更換，以免發生危險。

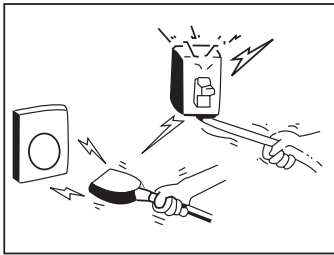

切勿用力拉扯電線。
損壞的電源線可以引致嚴重的觸電危險。

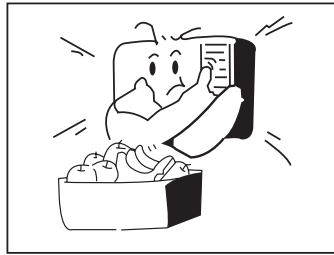

切勿使用冷氣機作冷卻房間以外的用途。
切勿使用冷氣機作乾衣、保存食物或培植蔬菜的用途。



切勿阻塞吸風和出風口，以免降低效能及引致冷氣機不正常運作。
切勿在空氣孔口插入木條或其他物件，以免在接觸電器組件及風扇時產生危險。

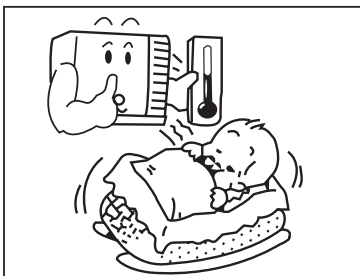

選擇最合適的溫度。
小心調節溫度以符合個人需要。嬰兒、老人或病人身處的房間應保持合適的溫度。

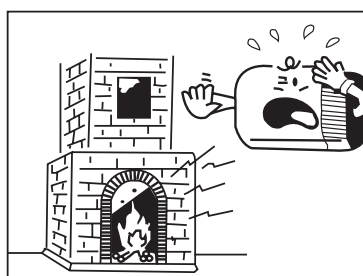

切勿在附近使用發熱產品，過熱會令冷氣機的塑膠組件溶化。

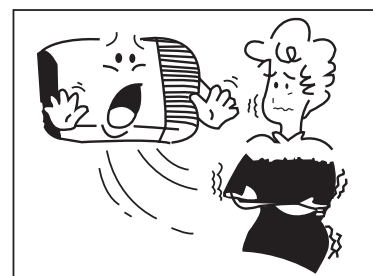

為健康著想，避免把身體長時間直接暴露在持續及單一方向的氣流下。

在製冷或製熱期間關閉冷氣機後，至少要等待三分鐘才可再次啟動。小童不應在沒有監護人的情況下，使用此冷氣機。

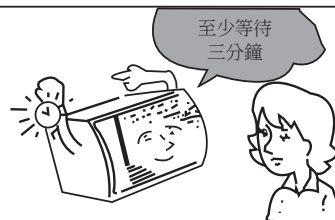

● 保養及維修

清洗主機

1. 清潔前先中斷電源供應。

在冷氣機完全關閉，才把插頭拔出

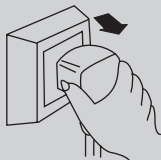

2. 使用軟布清潔機身。

若機身太過骯髒，可把軟布浸在水溫攝氏40度以下的溫水中，扭乾軟布 並 擦拭污物。



清潔前用手扭乾軟布

3. 切勿使用噴霧氣體、苯、溶劑、洗滌劑、化學溶劑等清洗冷氣機。



4. 切勿直接把水濺進冷氣機內。在機身內的微型電腦及電路板絕不可被水弄濕。



會發生意外

空氣過濾網

入風格柵後面的空氣過濾網，應在有需要時，或最少每兩星期清洗一次。

如何清洗空氣過濾網：

1. 移除入風格柵，抓緊過濾網上的夾片，然後拉出。

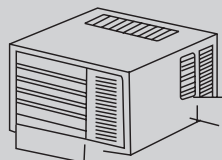

2. 把過濾網沾塵面的微塵吸掉。

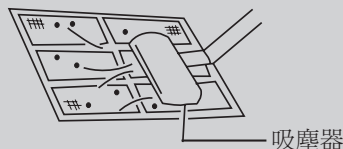

吸塵器

3. 清洗過濾網，在緩緩的水流下，洗去積聚的塵垢。



4. 若過濾網非常骯髒，可在清洗的水中，加入溫和的家用清潔劑。



待過濾器徹底乾透再重新裝上。

若有需要時，可向專業維修人員查詢清洗的方法。

* 檢查地線

是否損毀或鬆脫？

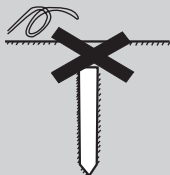

* 檢查室外冷氣機的入風及出風口有否阻塞

不能流通的空氣，可引致效能變差







注意：

為確保安全，每次清洗冷氣機前應關閉冷氣機及電源。

● 故障排除指南

在維修前，可先查看下表，以節省時間及金錢。

故障現象	故障處理
冷氣機完全不能操作 	<ul style="list-style-type: none"> * 電源供應是否出現故障？ * 插頭是否拔出？ * 電源保險絲或電掣是否關上？ * 電壓是否過高或過低？
製冷效果不佳 	<ul style="list-style-type: none"> * 空氣入風口或出風口是否被阻塞？ * 在房間內有否其他發熱源頭？ * 空氣過濾網是否太骯髒？ * 室內風速是否調較至LOW（低）的位置？ * 或者房間在冷氣機運作時太熱。 * 是否被陽光直接照射？
釋出有霧空氣 	<ul style="list-style-type: none"> * 在製冷模式(COOL)時，由於房間潮濕的空氣被迅速冷卻，偶爾會有霧氣從室內冷氣機釋出。 * 由於吸入的空氣有可能混雜傢具及蒸汽的氣味，因此室內出風口釋出一些氣味亦屬正常狀態。
冷氣機操作時發出噪音 	<ul style="list-style-type: none"> * 聽到像流水的聲音：這是製冷劑在冷氣機內流動的聲音。 * 像淋浴的聲音：這是處理除濕水份在冷氣機內的聲音。 這是正常的。
冷凝水好像從冷氣機中滲漏	<ul style="list-style-type: none"> * 當冷氣機的氣流冷卻室內溫暖的空氣時，便會產生冷凝現象。
冷氣機在重新啓動後三分鐘未能運作	<ul style="list-style-type: none"> * 這是用作保護機械裝置。 * 等候三分鐘，冷氣機會開始運作。

● 售後服務

當發生以下情況時，請立即停止操作，拔掉插頭，並聯絡閣下的零售商。

- *不正常地開始或停止操作；
- *電源保險絲或開關經常跳掣；
- *不小心把水或其他物質濺進冷氣機內；
- *電線過熱或電線出現裂痕；
- *出現其他特殊情況。



棄置說明

棄置包裝物料

1. 包裝物料為100%環保，並且有回收標誌。包裝物料不能分散棄置，必須符合所在當地有關法規的規定。
2. 本產品包含製冷劑氣體，為密封系統的氟化溫室氣體。
製冷劑氣體：R410a具有了全球警告潛能值（GWP）1975。
3. 有關處理和回收該產品及其包裝更詳細的信息，請聯繫當地有關機構或您購買本產品的商店作廢物回收。

報廢家電

4. 本產品已經取得了可回收或可重複使用的材料。報廢必須符合當地的垃圾處理規定進行。報廢之前，一定要切斷電源線，使設備無法重新使用。
5. 在產品或者產品附帶的文檔中有此標誌表示該產品不能被當作生活垃圾處理，但必須棄於用作存儲或回收電子/電器產品的地方。
6. 遙控器中的電池需正確地回收或丟棄。電池應做為有害垃圾由有資質的回收點回收。



Register your product online

網上登記新產品保養

Save the planet and register your product warranty online!
Enjoy extra 1-month free warranty upon online registration.

「惠」環保出力，減少用紙！於網上登記產品更可獲額外多一個月保養。



<https://rebrand.ly/WPwarranty>

Whirlpool® Registered trademark/TM Trademark of Whirlpool group of companies

All rights reserved - <http://www.whirlpool.com.hk>

註冊商標/惠而浦集團的TM商標

版權所有 翻印必究 - <http://www.whirlpool.com.hk>



Whirlpool